

VITAM-9XXA Series

15", 15.6", 17", 19", 21.5", and 23.8" 6th Generation IP66/IP69K
Stainless Steel Panel PC

User Manual

Release Date

Revision

May 2020

V1.8

©2020 Aplex Technology, Inc.

All Rights Reserved.

Published in Taiwan

Aplex Technology, Inc.

15F-1, No.186, Jian Yi Road, Zhonghe District, New Taipei City 235, Taiwan

Tel: 886-2-82262881 Fax: 886-2-82262883 URL: <http://www.aplextec.com/zh/home.php>

Revision History

Reversion	Date	Description
1.0	2017/10/11	Official Version
1.1	2017/11/07	Add UPS battery
1.2	2018/01/29	Modify OS status/High brightness description
1.3	2018/11/01	Modify Operating temperature
1.4	2018/11/23	Revise Backlight Lifetime information
1.5	2019/06/27	Revise 1.1 Specification data
1.6	2019/08/06	Add Logistic Statement
1.7	2020/01/02	Revise SBC-7114 Information
1.8	2020/05/26	Revise 1.1 specification data

Warning!

This equipment generates, uses and can radiate radio frequency energy and if not installed and used in accordance with the instructions manual, it may cause interference to radio communications. It has been tested and found to comply with the limits for a Class A computing device pursuant to FCC Rules, which are designed to provide reasonable protection against such interference when operated in a commercial environment. Operation of this equipment in a residential area is likely to cause interference in which case the user at his own expense will be required to take whatever measures may be required to correct the interference.

Electric Shock Hazard – Do not operate the machine with its back cover removed. There are dangerous high voltages inside.

Caution

Risk of explosion if the battery is replaced with an incorrect type.

Batteries should be recycled where possible. Disposal of used batteries must be in accordance with local environmental regulations.

Disclaimer

This information in this document is subject to change without notice. In no event shall Apex Technology Inc. be liable for damages of any kind, whether incidental or consequential, arising from either the use or misuse of information in this document or in any related materials.

Packing List

Accessories (as ticked) included in this package are:
<input type="checkbox"/> Adaptor
<input type="checkbox"/> Driver & manual CD disc
<input type="checkbox"/> Other. _____ (please specify)

Safety Precautions

Follow the messages below to prevent your systems from damage:

- ◆ Avoid your system from static electricity on all occasions.
- ◆ Prevent electric shock. Don't touch any components of this card when the card is power-on. Always disconnect power when the system is not in use.
- ◆ Disconnect power when you change any hardware devices. For instance, when you connect a jumper or install any cards, a surge of power may damage the electronic components or the whole system.

Dear Valued Partners

Thank you for supporting APLEX Technology. Kindly note for ViTAM series, the pressure testing screw is loosen for half turn before shipment. The purpose is to avoid potential quality concerns caused by radical air pressure change during transportation. This especially applies to air shipment with unpressurized cabin.

Upon receiving the system, please tighten the pressure testing screw before deployment to ensure 100% functionality.

Here is our suggestion:

1. Prepare a 3mm hex screwdriver
2. Tighten the screw (indicated in circle) clockwise until it is well in place
3. Recommend torque is 8~10 kgf-cm

Apologies for any inconveniences caused and thank you for your cooperation.

Yours Sincerely

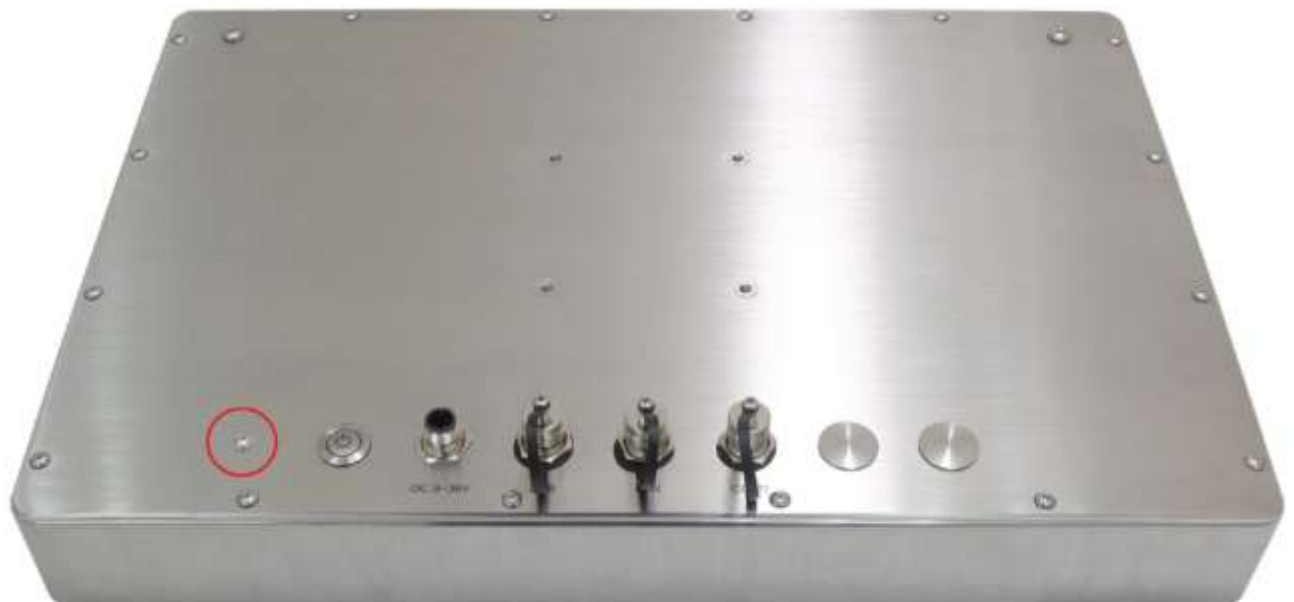

Table of Contents

Revision History.....	1
Warning!/Caution/Disclaimer.....	2
Packing List.....	3
Safety Precautions.....	4
Logistic Statement.....	5

Chapter 1 Getting Started

1.1 Features.....	7
1.2 Specifications.....	7
1.3 Dimensions.....	11
1.4 Brief Description of VITAM-9XXA Series.....	14
1.5 Yoke Mounting and VESA Mounting.....	15

Chapter 2 Hardware

2.1 Motherboard Introduction.....	16
2.2 Specifications.....	16
2.3 Jumpers and Connectors Location.....	20
2.4 Jumpers Setting and Connectors.....	21

Chapter 3 BIOS Setup

3.1 Operations after POST Screen.....	58
3.2 BIOS Setup Utility.....	58
3.3 Main Settings.....	59
3.4 Advanced Settings.....	60
3.5 Chipset Settings.....	69
3.6 Security Settings.....	92
3.7 Boot Settings.....	94
3.8 Save & Exit Settings.....	95

Chapter 4 Installation of Drivers

4.1 Intel H170 Chipset.....	98
4.2 Intel® HD Graphics 530 Chipset.....	101
4.3 Realtek ALC662 HD Audio Driver Installation.....	105
4.4 Intel® Management Engine Interface.....	107
4.5 DPTF Driver.....	110

Chapter 5

Touch Screen Installation

5.1 Windows 8.1/10 Universal Driver Installation.....	115
5.2 Software Function.....	119

Figures

Figure 1.1: Dimensions of VITAM-915AP/R/G(H).....	11
Figure 1.2: Dimensions of VITAM-916AP/R/G(H).....	11
Figure 1.3: Dimensions of VITAM-917AP/R/G(H).....	12
Figure 1.4: Dimensions of VITAM-919AP/R/G(H).....	12
Figure 1.5: Dimensions of VITAM-921AP/R/G(H).....	13
Figure 1.6: Dimensions of VITAM-924AP/G(H).....	13
Figure 1.7: Front View and Touch on/off Button of VITAM-9XXA Serie.	14
Figure 1.8: Rear View of VITAM-9XXA Series.....	14
Figure 1.9: Yoke Mounting of VITAM-9XXA Series.....	15
Figure 1.10: VESA Mounting of VITAM-9XXA Series.....	15
Figure 2.1: Motherboard Dimensions.....	19
Figure 2.2: Jumpers and Connectors Location-Board Top.....	20
Figure 2.3: Jumpers and Connectors Location-Board Bottom.....	20

Chapter 1

Getting Started

1.1 Features

- 15"/15.6"/17"/19"/21.5"/23.8" New Gen. stainless steel panel PC
- 6th Gen. Intel Core i3/i5 BGA type processor
- True flat front bezel design and Grade 304 Stainless Steel enclosure (Grade 316 for option)
- IP66/IP69K rated with M12 connectors
- Support Resistive Touch, Projected Capacitive Touch, and Glass
- Touch on/off button on the side edge for Hygienic Cleaning
- Support ergonomic versatile mounting: Yoke mounting, VESA mounting, and Swing arm mounting.

1.2 Specifications

	VITAM-915 AP/R/G/(H)	VITAM-916 AP/R/G/(H)	VITAM-917 AP/R/G/(H)	VITAM-919 AP/R/G/(H)	VITAM-921 AP/R/G/(H)	VITAM-924 AP/G/(H)															
System																					
CPU	Intel Core i5-6300U Processor(3M Cache, up to 3.00 GHz) Intel Core i3-6100U Processor(3M Cache, up to 2.30 GHz)																				
Chipset	SoC																				
Memory	1 x 260-pin SO-DIMM up to 16GB DDR4 2133MHz																				
Outside IO Port – Standard M12 I/O Connector on the Rear Side																					
USB	1 x M12 8-pin for USB2.0 with waterproof cover and chain																				
	USB1/2: <table border="1" data-bbox="470 1442 807 1951"> <thead> <tr> <th>CN1</th> <th>Pin Define</th> </tr> </thead> <tbody> <tr> <td>1</td> <td>USB1 5V</td> </tr> <tr> <td>3</td> <td>D1-</td> </tr> <tr> <td>4</td> <td>D1+</td> </tr> <tr> <td>7</td> <td>GND</td> </tr> <tr> <td>2</td> <td>USB2 5V</td> </tr> <tr> <td>5</td> <td>D2-</td> </tr> <tr> <td>6</td> <td>D2+</td> </tr> <tr> <td>8</td> <td>GND</td> </tr> </tbody> </table>						CN1	Pin Define	1	USB1 5V	3	D1-	4	D1+	7	GND	2	USB2 5V	5	D2-	6
CN1	Pin Define																				
1	USB1 5V																				
3	D1-																				
4	D1+																				
7	GND																				
2	USB2 5V																				
5	D2-																				
6	D2+																				
8	GND																				
Serial/Parallel	1 x M12 8-pin COM1, RS-232/422/485, Default RS-232,																				

	with waterproof cover and chain	<table border="1"> <thead> <tr> <th></th> <th>Pin Define</th> </tr> </thead> <tbody> <tr> <td>1</td> <td>DCD</td> </tr> <tr> <td>2</td> <td>RXD</td> </tr> <tr> <td>3</td> <td>TXD</td> </tr> <tr> <td>4</td> <td>DTR</td> </tr> <tr> <td>5</td> <td>GND</td> </tr> <tr> <td>6</td> <td>DSR</td> </tr> <tr> <td>7</td> <td>RTS</td> </tr> <tr> <td>8</td> <td>CTS</td> </tr> </tbody> </table>		Pin Define	1	DCD	2	RXD	3	TXD	4	DTR	5	GND	6	DSR	7	RTS	8	CTS	
	Pin Define																				
1	DCD																				
2	RXD																				
3	TXD																				
4	DTR																				
5	GND																				
6	DSR																				
7	RTS																				
8	CTS																				

LAN	1 x M12 8-pin for LAN with waterproof cover and chain	<p>LAN:</p> <table border="1"> <thead> <tr> <th></th> <th>Pin Define</th> </tr> </thead> <tbody> <tr> <td>1</td> <td>LAN1_0+</td> </tr> <tr> <td>2</td> <td>LAN1_0-</td> </tr> <tr> <td>3</td> <td>LAN1_1+</td> </tr> <tr> <td>4</td> <td>LAN1_1-</td> </tr> <tr> <td>5</td> <td>LAN1_2+</td> </tr> <tr> <td>6</td> <td>LAN1_2-</td> </tr> <tr> <td>7</td> <td>LAN1_3+</td> </tr> <tr> <td>8</td> <td>LAN1_3-</td> </tr> </tbody> </table>		Pin Define	1	LAN1_0+	2	LAN1_0-	3	LAN1_1+	4	LAN1_1-	5	LAN1_2+	6	LAN1_2-	7	LAN1_3+	8	LAN1_3-	
	Pin Define																				
1	LAN1_0+																				
2	LAN1_0-																				
3	LAN1_1+																				
4	LAN1_1-																				
5	LAN1_2+																				
6	LAN1_2-																				
7	LAN1_3+																				
8	LAN1_3-																				

Power	1 x M12 3-pin for DC power with waterproof cover and chain	<table border="1"> <thead> <tr> <th></th> <th>Pin Define</th> </tr> </thead> <tbody> <tr> <td>1</td> <td>NC</td> </tr> <tr> <td>3</td> <td>VCC</td> </tr> <tr> <td>4</td> <td>GND</td> </tr> </tbody> </table>		Pin Define	1	NC	3	VCC	4	GND	
	Pin Define										
1	NC										
3	VCC										
4	GND										

Others	<p>1 x Power Switch on the rear</p> <p>1 x Touch on/off button at the side</p>
--------	--

Option I/O Port (Either two)	
	2 x optional blank M12 connectors with waterproof cap for selecting two from the following options:

Option	2 x USB 2.0 1 x USB 3.0 1 x LAN (POE for option) 1 x COM 1 x CAN					
Storage Space						
Storage	1 x 2.5" SATA3 HDD					
Expansion						
Expansion Slot	1 x Mini PCIe slot for WIFI/BT and Antenna at rear side (option)					
RFID module	RFID module design on the front side (option)					
Display – Standard LCD						
Display Type	15" TFT LCD	15.6" TFT LCD	17" TFT LCD	19" TFT LCD	21.5" TFT LCD	23.8" TFT LCD
Max. Resolution	1024 x 768	1366 x 768	1280 x 1024	1280 x 1024	1920 x 1080	1920 x 1080
Max. Color	262K/16.2M	16.7M	16.7M	16.7M	16.7M	16.7M
Luminance (cd/m ²)	300	300	350	350	250	250
Contrast Ratio	2000:1	500:1	800:1	1000:1	3000:1	3000 : 1
Viewing Angle	176(H)/ 176(V)	160(H)/ 160(V)	160(H)/ 140(V)	170(H)/ 160(V)	178(H)/ 178(V)	178(H)/ 178(V)
Backlight Lifetime	70,000hrs	50,000hrs	50,000hrs	50,000hrs	30,000hrs	30,000 hrs
Option	Optical bonding					
Display – High Brightness LCD (option)						
Display Type	15" TFT LCD	15.6" TFT LCD	17" TFT LCD	19" TFT LCD	21.5" TFT LCD	23.8" TFT LCD
Max. Resolution	1024 x 768	1366x768	1280 x1024	1280 x1024	1920x1080	1920x1080
Max. Color	16.7M	16.7M	16.7M	16.7M	16.7M	16.7M
Luminance (cd/m ²)	1000	1000	1000	1000	1000	1000
Contrast Ratio	800:1	500:1	1000:1	1000:1	3000:1	3000:1
Viewing Angle	160(H)/ 150(V)	160(H)/ 160(V)	170(H)/ 160(V)	170(H)/ 160(V)	178(H)/ 178(V)	178(H)/ 178(V)
Backlight Lifetime	50,000hrs	50,000hrs	50,000hrs	50,000hrs	50,000hrs	30,000hrs
Option	Optical bonding					
Touch Screen						
Type	Resistive touch window (for R model) (not available for 23.8") Projected capacitive touch screen (for P model) Glass (for G model)					

Interface	USB					
Light Transmission	Resistive touch window: over 80% Projected capacitive touch screen: over 90%					
Glass Type						
Type	AR					
Light Transmission	Over 90%					
Power						
Power Input	DC 9~36V					
Power Consumption	MAX:TBD (915AR) MAX:35W (915AP)	MAX:TBD (916AR) MAX:49W (916AP)	MAX:TBD (917AR) MAX:49W (917AP)	MAX:TBD (919AR) MAX:49W (919AP)	MAX:TBD (921AR) MAX:43W (921AP)	MAX:53W (924AP)
Mechanical						
Color	304 Stainless steel enclosure (default) 316 Stainless steel enclosure (option)					
Construction	Stainless steel enclosure					
Mounting	VESA mount 75 x 75, Yoke mount			VESA mount 100 x 100, Yoke mount		VESA mount 200 x 100, Yoke mount
IP Rating	IP66/IP69K					
Dimension (mm)	399 x 324 x 53	440 x 290 x 55	432 x 358 x 55	470 x 388.6 x 60	571 x 362 x 55	656 x 423 x 53
Net Weight	7.1 Kg	7 Kg	8.2 Kg	9.5 Kg	10 Kg	12.6 Kg
Environmental						
Operating temperature	0~50°C	0~50°C	0~50°C	0~50°C	0~50°C 0~40°C(For High Bright model)	0~50°C
Storage temperature	-30~70°C					
Storage humidity	10 to 95% @ 40°C, non- condensing (10~95%for 23.8" model)					
Certification	Meet CE / FCC Class A					
Operating System Support	Windows Embedded 7, Windows Embedded 8.1, Windows 10 IoT ENT LTSB					

1.3 Dimensions

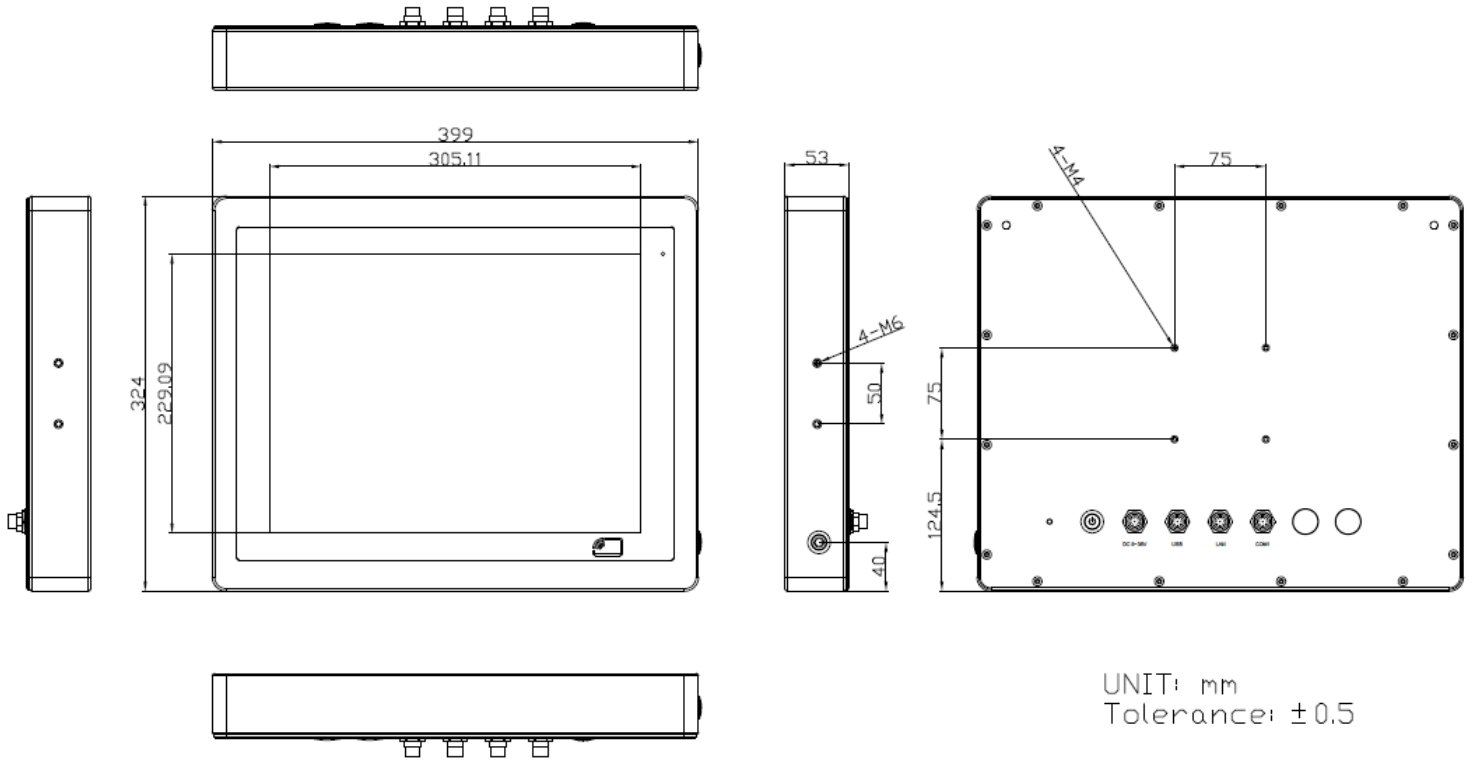

Figure 1.1: Dimensions of VITAM-915AP/R/G(H)

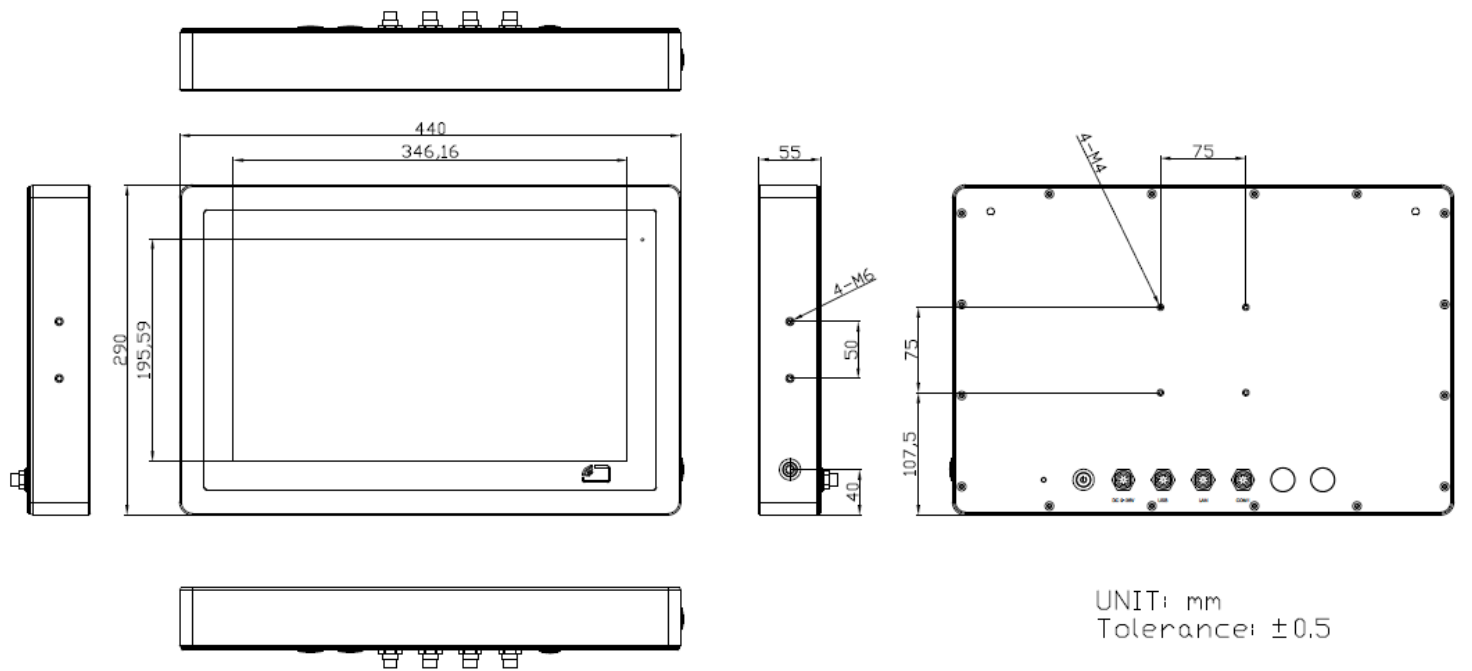

Figure 1.2: Dimensions of VITAM-916AP/R/G(H)

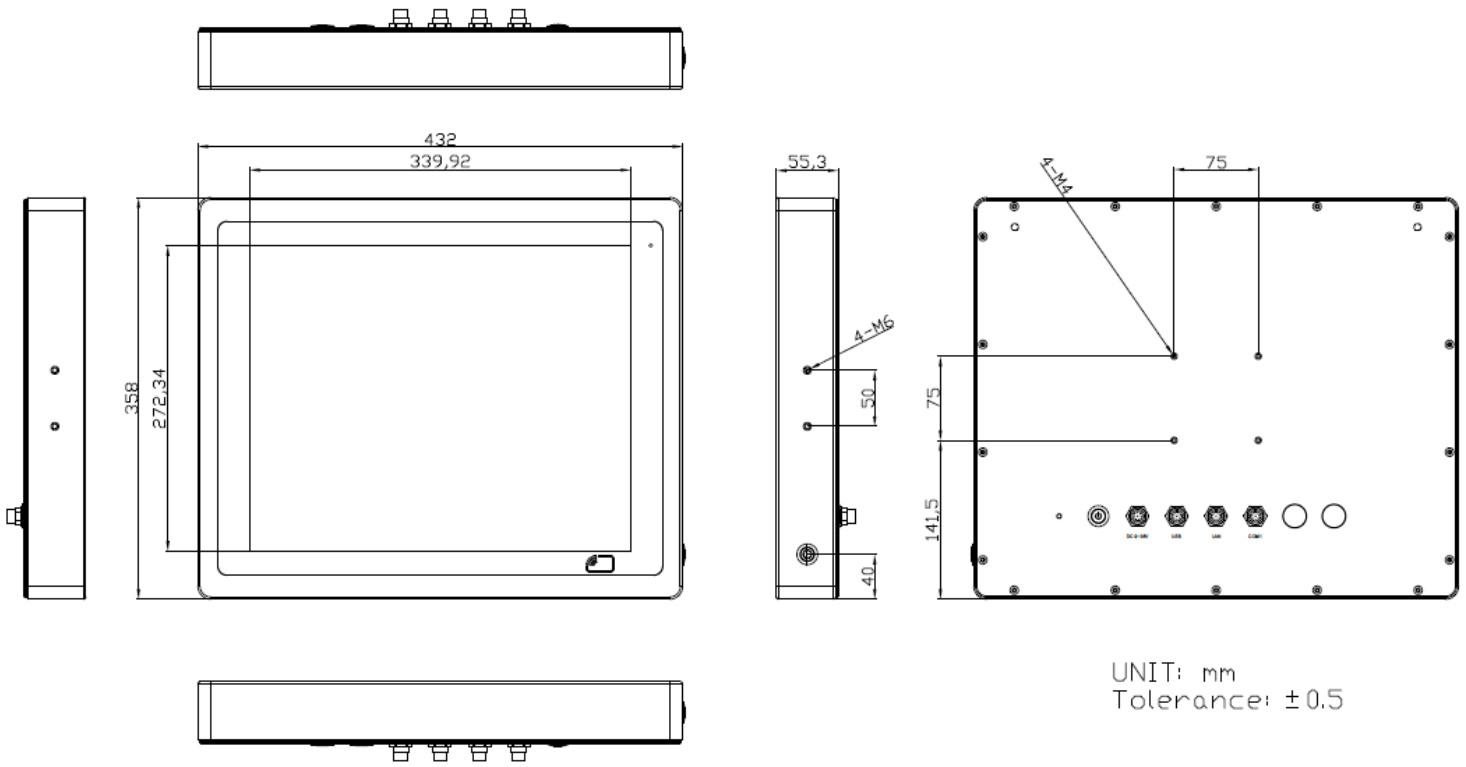

Figure 1.3: Dimensions of VITAM-917AP/R/G(H)

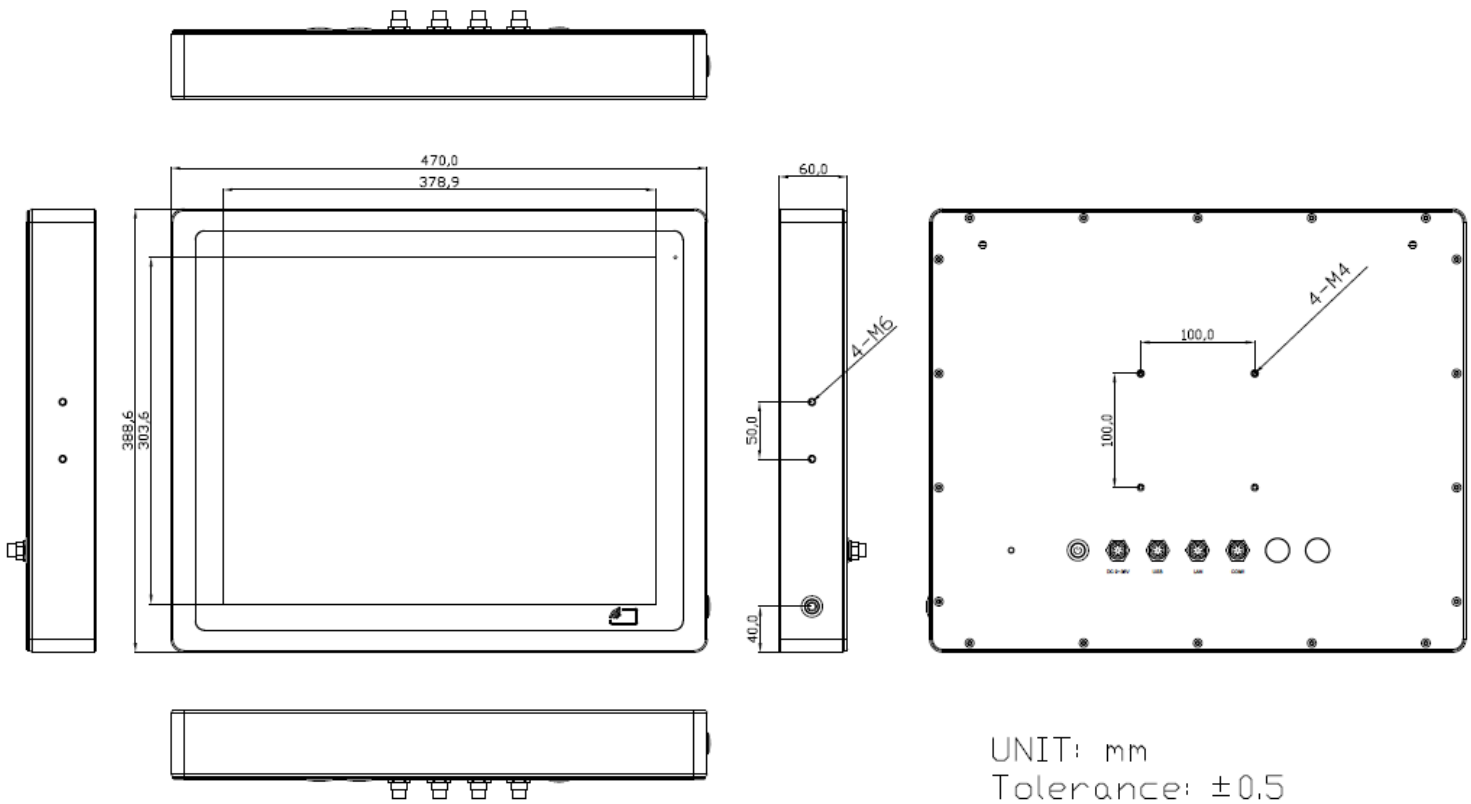

Figure 1.4: Dimensions of VITAM-919AP/R/G(H)

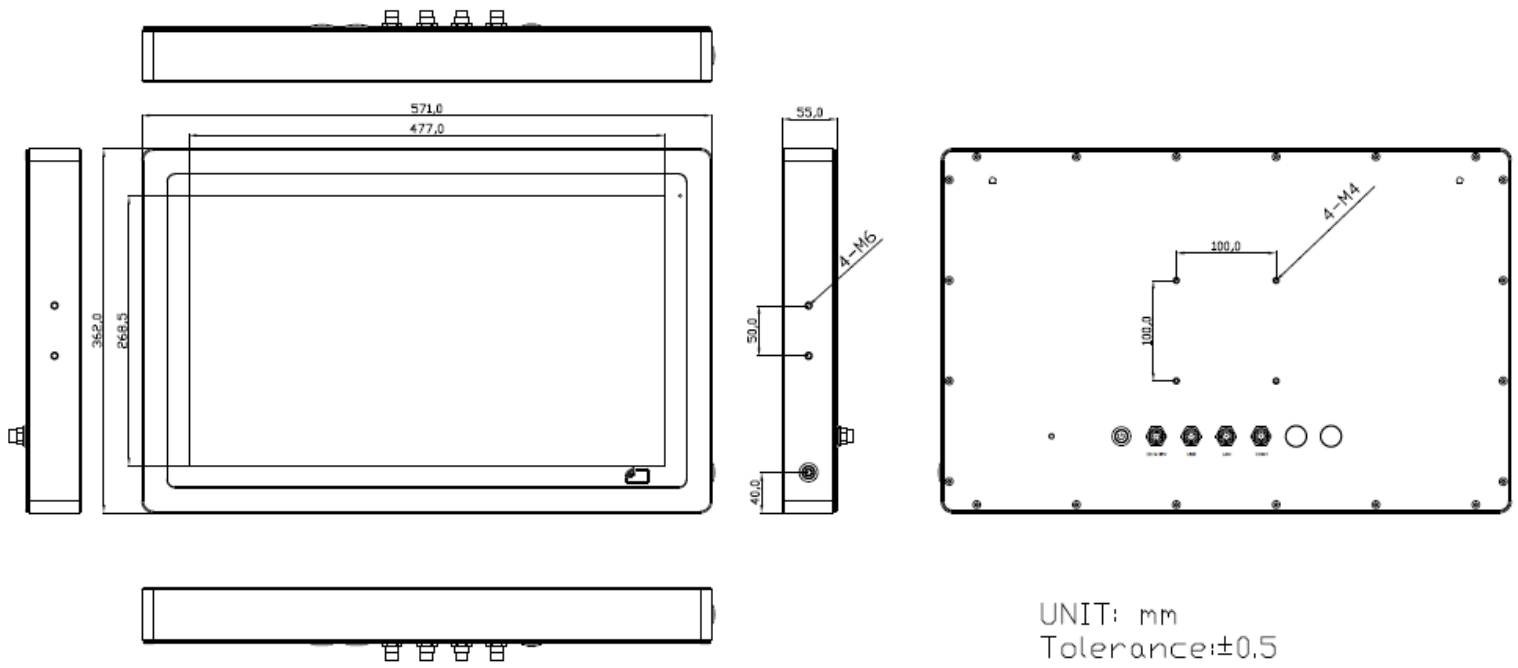

Figure 1.5: Dimensions of VITAM-921AP/R/G(H)

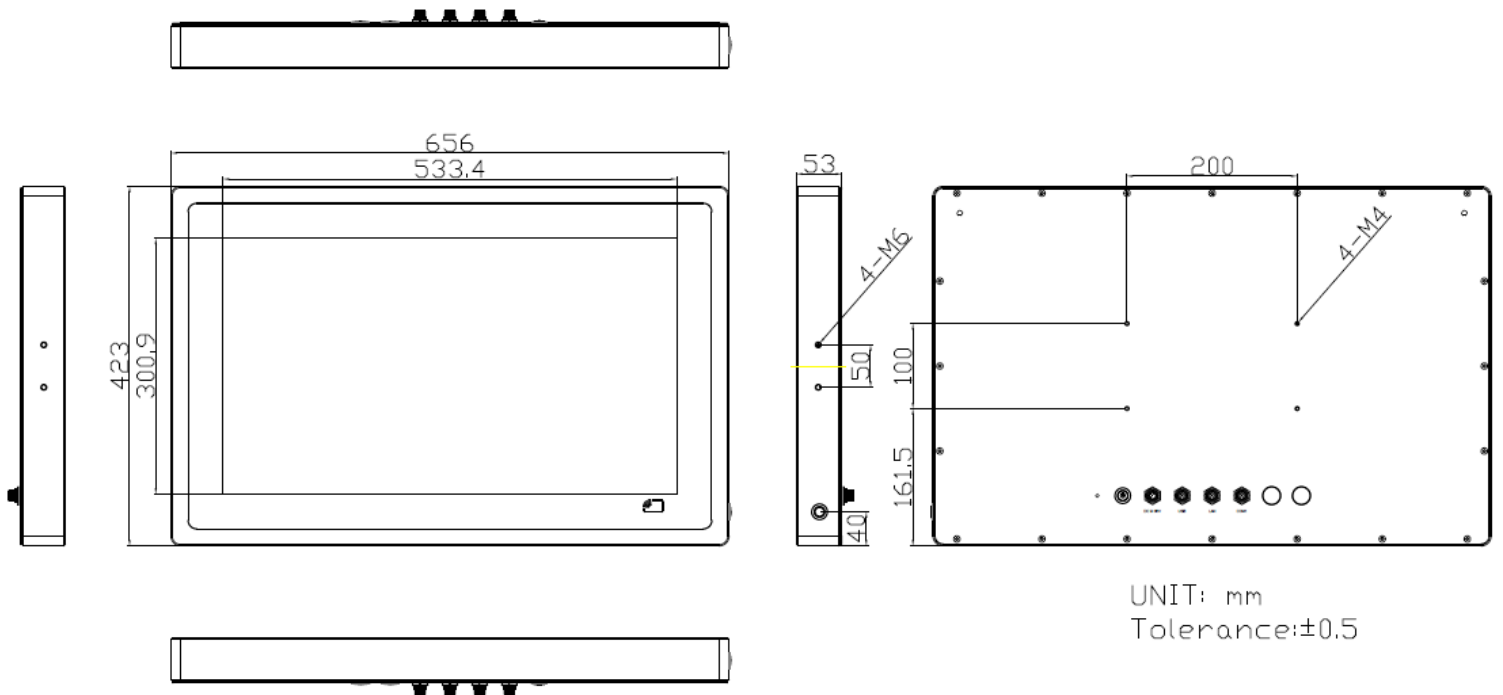

Figure 1.6: Dimensions of VITAM-924AP/G(H)

1.4 Brief Description of VITAM-9XXA Series

There are 15", 15.6", 17", 19", 21.5", and 24" new generation adopt the SUS304 grade stainless steel housing (SUS316 grade for option) panel PC in VITAM-9XXA series, which comes with 100% dust and waterproof guarantee, and the all-in-one fanless design. It is powered by 6th Gen. Intel Core i3-6100U/i5-6300U processor onboard, 1 x 260-pin SO-DIMM up to 16GB DDR4L 2133MHz memory, and 1 x 2.5" HDD/SSD space for storage. VITAM-9XXA series is wide range DC 9~36V power input and IP66/IP69K rated with M12 connectors. Furthermore, the models support resistive touch, projected capacitive touch, and glass for option, and can be high brightness LCD and optical bonding designed for option. It supports touch on/off button on the side edge for hygienic cleaning and ergonomic versatile mounting: Yoke mounting and space-saving VESA mounting.

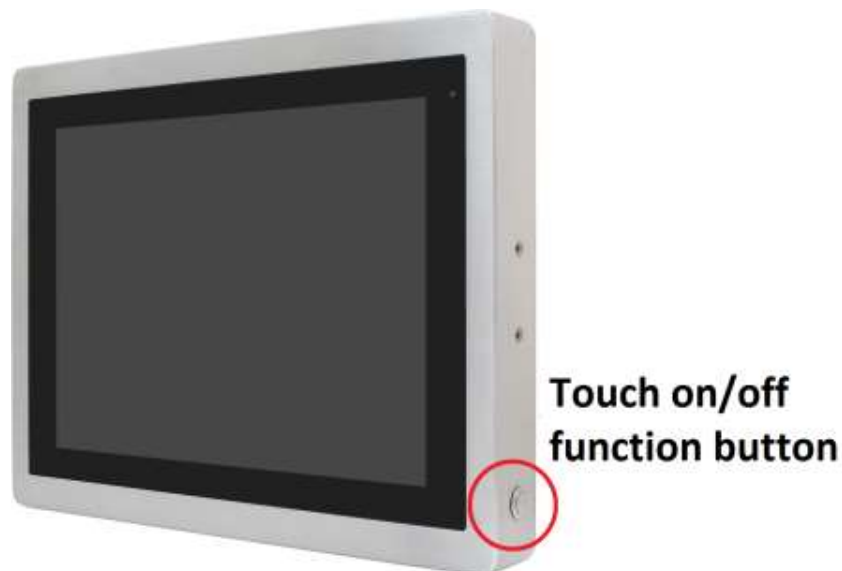

Figure 1.7: Front View and Touch on/off Button of VITAM-9XXA Series



Figure 1.8: Rear View of VITAM-9XXA Series

1.5 Yoke Mounting and VESA Mounting

The VITAM-9XXA Series model can be Yoke mounted and VESA mounted as shown in Picture below.



Figure 1.9: Yoke mounting of VITAM-9XXA Series



Figure 1.10: VESA mounting of VITAM-9XXA Series

2.1 Motherboard Introduction

SBC-7114 is a 4" industrial motherboard developed on the basis of Intel Skylake-U Processor, which provides abundant peripheral interfaces to meet the needs of different customers. Also, it features dual GbE ports, 6-COM ports and one mSATA configuration, one HDMI port, and one LVDS interface. To satisfy the special needs of high-end customers, CN1 and CN2 and CN3 richer extension functions. The product is widely used in various sectors of industrial control.

2.2 Specifications & Dimensions

Specifications	
Board Size	170mm x 113mm
CPU Support	Intel® Core™ i3-6100U/ 2.30GHz (onboard) Intel® Core™ i5-6300U/ 2.40 up to 3.00GHz (option) Intel® Core™ i7-6600U/ 2.60 up to 3.40GHz (option) Intel® Celeron 3955U/ 2.00GHz (option) Intel® Celeron 3965U/ 2.20GHz (option) Intel® Core™ i3-7100U/ 2.40GHz (option) Intel® Core™ i5-7300U/ 2.60 up to 3.50GHz (option) Intel® Core™ i7-7600U/ 2.80 up to 3.90GHz (option)
Chipset	SOC
Memory Support	1x SO-DIMM (260pins), up to 16GB DDR4 2133MHz FSB
Graphics	Intel® HD Graphics 520 (i3-6100U/i5-6300U/i7-6600U) Intel® HD Graphics 510 (3955U) Intel® HD Graphics 610 (3965U) Intel® HD Graphics 620 (i3-7100U/i5-7300U/i7-7600U)
Display Mode	1 x HDMI 1.4 Port 1 x LVDS (18/24-bit dual LVDS) 1 x DP Signal Port (DF13-40P)
Support Resolution	Up to 4096 x 2304 for HDMI Up to 1920 x 1200 for LVDS (PS8625) Up to 4096 x 2304 for DP1
Dual Display	HDMI + LVDS

	<p>HDMI + DP1 (option)</p> <p>LVDS + DP1 (option)</p> <p>HDMI + LVDS + DP1 (option)</p>
Super I/O	Nuvoton NCT6106D
BIOS	AMI/UEFI
Storage	<p>1 x SATAIII Connector (7P)</p> <p>1 x SATAIII Connector (7P+15P)</p> <p>1 x MSATA Connector (option)</p>
Ethernet	2 x PCIe GbE LAN by Intel I210-AT
USB	<p>2 x USB 3.0 (type A)stack ports (USB3) (USB3.0:USB3-1/USB3-2,USB2.0:USB1/USB2)</p> <p>4 x USB 2.0 Pin header for CN3 (USB3/USB4/USB8/USB9)</p> <p>2 x USB 3.0/USB2.0 Pin header for CN3 (PCIe 1x or USB3.0, option)</p> <p>1 x USB 2.0 Pin header for CN2 (USB5)</p> <p>1 x USB 2.0 Pin header for CN1 (USB7 or Touch, option)</p> <p>1 x USB 2.0 Pin header for EDP1 (USB7 or Touch, option)</p> <p>1 x USB 2.0 for MPCIE1 (USB6)</p>
Serial	<p>1 x RS232/RS422/RS485 port, DB9 connector for external (COM1) Pin 9 w/5V/12V/Ring select</p> <p>1 x RS232 port, DB9 connector for external (COM2) Pin 9 w/5V/12V/Ring select</p> <p>2 x UART for CN3 (COM3,COM4)</p> <p>1 x RS422/485 header for CN2 (NCT6106D /COM5)</p> <p>1 x RS422/485 header for CN2 (NCT6106D /COM6)</p>
Digital I/O	<p>8-bit digital I/O by Pin header (CN2)</p> <p>4-bit digital Input</p> <p>4-bit digital Output</p> <p>4-bit digital I/O by Pin header (CN3)</p> <p>2-bit digital Input</p> <p>2-bit digital Output</p>
Battery	Support CR2477 Li battery by 2-pin header (BAT3/CMOS)
Smart battery	<p>1 x Smart battery</p> <p>Support 3 Serial Li battery by 10-pin header (BAT2)</p>
Audio	<p>Support Audio via Realtek ALC269Q HD audio codec</p> <p>Support Line-out by JACK (LINE_OUT1)</p>

	<p>Support Line-in, Line-out, MIC by 2x6-pin header(AUDIO2)</p> <p>Support a stereo Class-D Speaker Amplifier with 2 watt per channel output power, by 1x4-pin header (SPK1)</p>
Expansion Bus	<p>1 x mini-PCI-express slot (MPCIE or MSATA. Default: MSATA)</p> <p>1 x PCI-express for CN3</p> <p>2 x PCI-express for CN3 (PCIe 1x or USB3.0, Default : PCIe 1x)</p>
TPM	<p>Infineon's Trusted Platform Module (TPM2.0)</p> <p>*Note: Only support Windows 10 IOT*</p>
Touch Ctrl	<p>1 x Touch ctrl header for TCH1 (USB10)</p>
Power Management	<p>Wide Range DC9V~36V input</p> <p>1 x 3-pin power input connector</p>
Switches and LED Indicators	<p>1 x Power on/off switch (BT1/BT2/CN2/CN3)</p> <p>1 x Reset (CN2)</p> <p>1 x HDD LED status (CN2)</p> <p>1 x Power LED status (CN1)</p> <p>1 x Buzzer</p>
External I/O port	<p>2 x COM Ports (COM1/COM2)</p> <p>2 x USB 3.0 Ports (stack)</p> <p>2 x RJ45 GbE LAN Ports</p> <p>1 x HDMI Port</p> <p>1 x Audio Jack (Line out)</p>
Temperature	<p>Operating: -20°C to 70°C</p> <p>Storage: -40°C to 85°C</p>
Humidity	<p>10% - 90%, non-condensing, operating</p>
Power Consumption	<p>12V/3A (Intel i3-7100U 2.40 GHz Processor with 16GB DDR4/HDD)</p>
EMI/EMS	<p>Meet CE/FCC class A</p>

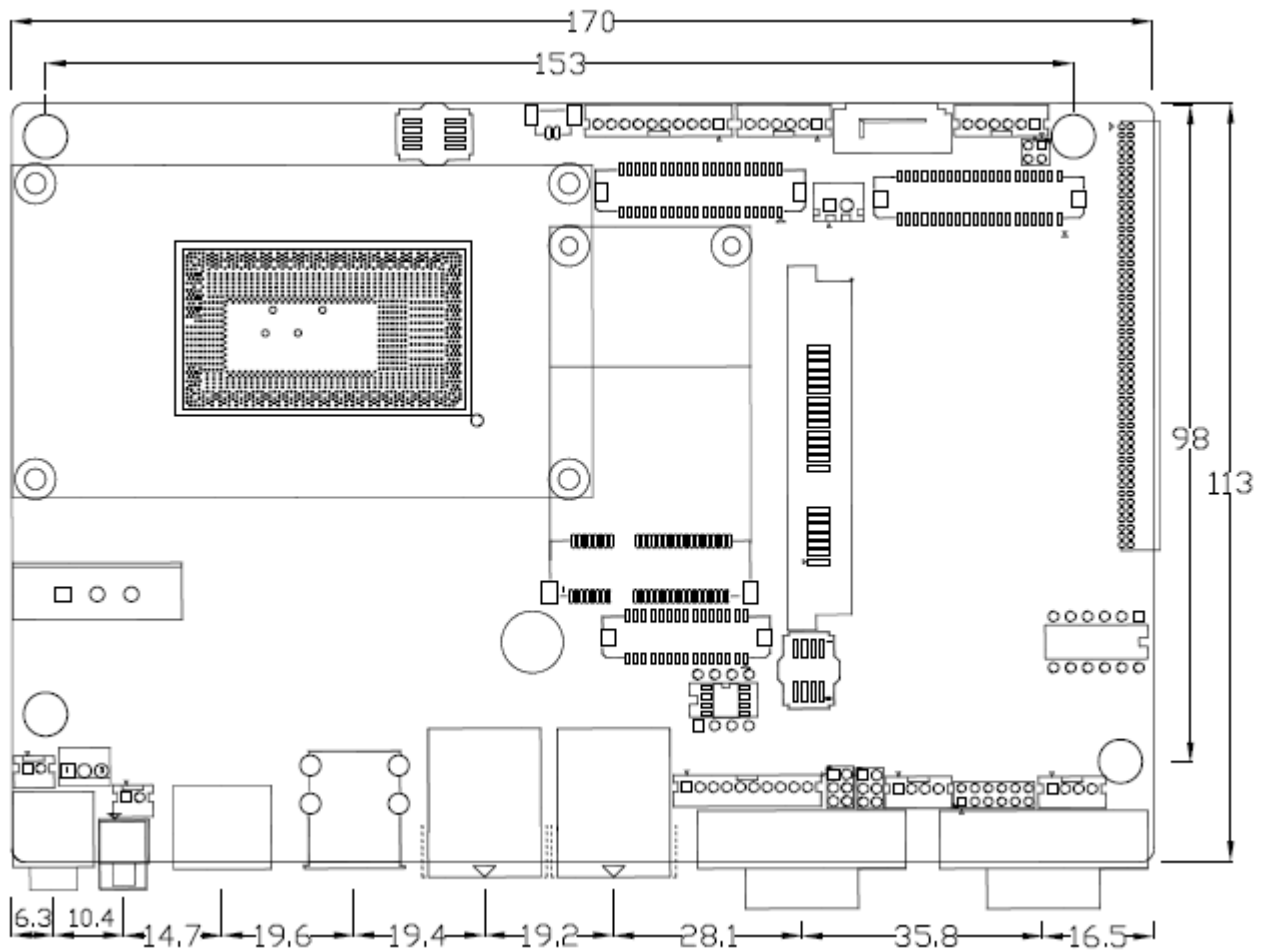

(Unit: mm)

Figure 2.1: Motherboard Dimensions

2.3 Jumpers and Connectors Location

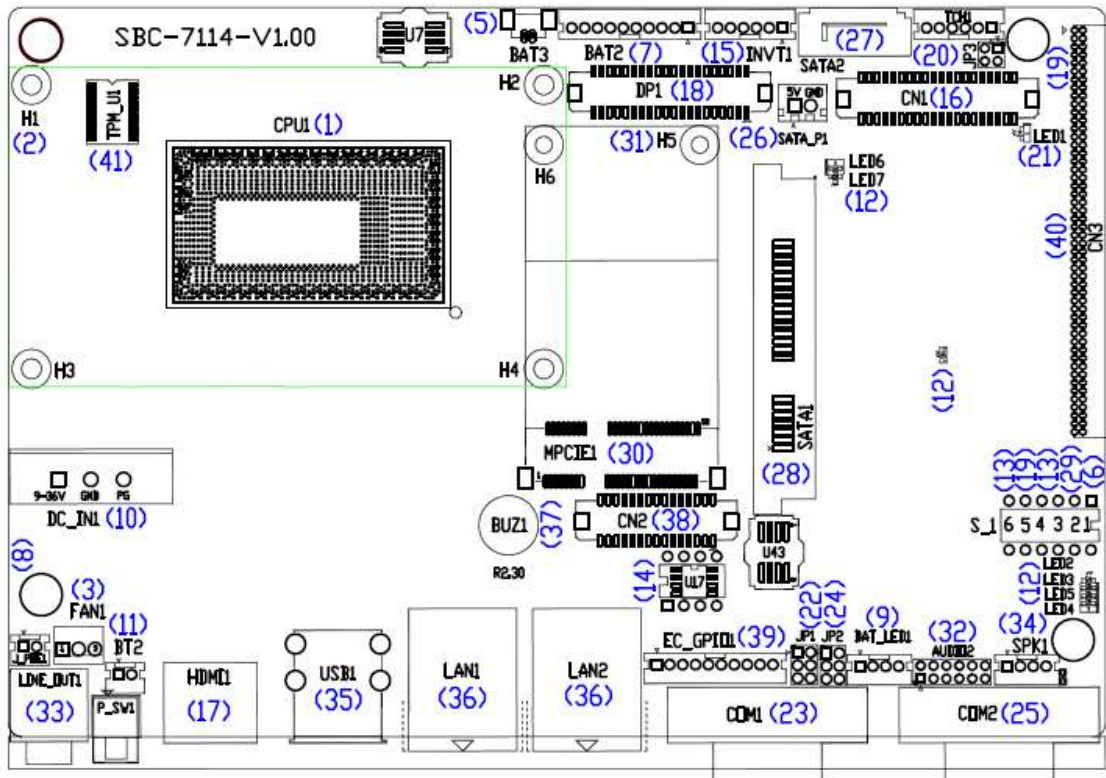

Figure 2.2: Jumpers and Connectors Location- Board Top

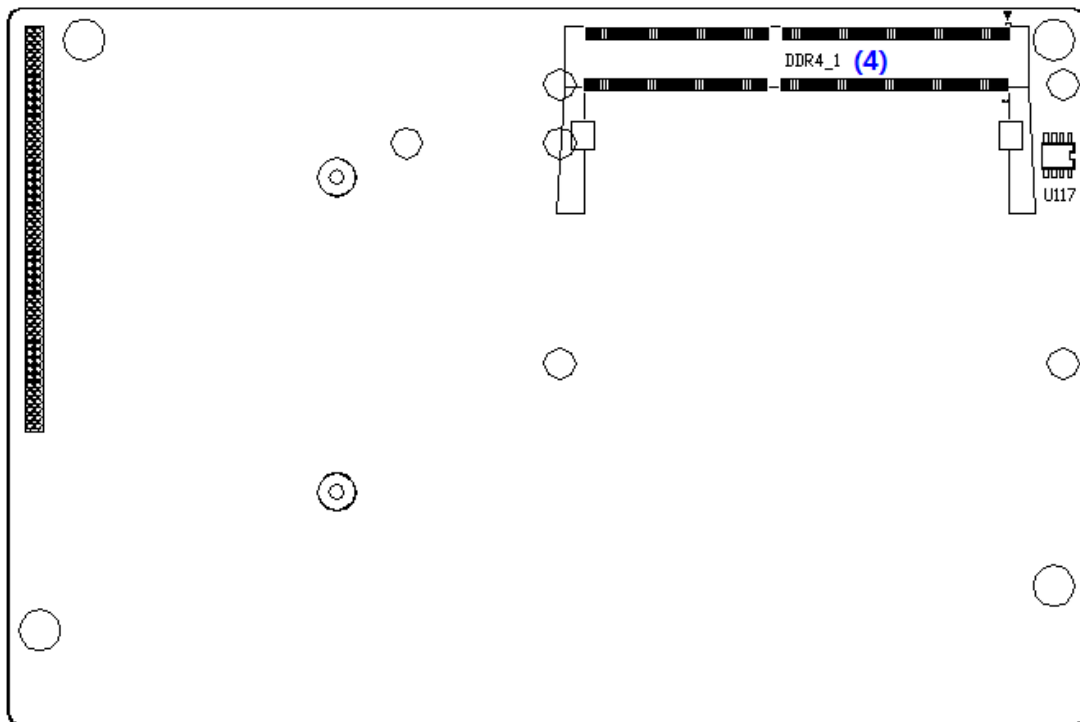

Figure 2.3: Jumpers and Connectors Location- Board Bottom

2.4 Jumpers Setting and Connectors

1. CPU1:

(FCBGA1356), onboard Intel Skylake-U processors

Model	Processor					
	Number	PBF	Cores/ Threads	TDP	Embedded	Remarks
SBC-7114-I3-6100U	I3-6100U	2.30GHz	2 / 4	15W	●	
SBC-7114-I3-6100UP	I3-6100U	2.30GHz	2 / 4	15W	●	option
SBC-7114-I5-6300U	I5-6300U	2.4 up to 3.0GHz	2 / 4	15W 25W	●	option
SBC-7114-I5-6300UP	I5-6300U	2.4 up to 3.0GHz	2 / 4	15W 25W	●	option
SBC-7114-I7-6600U	I7-6600U	2.6 up to 3.4GHz	2 / 4	15W 25W	●	option
SBC-7114-I7-6600UP	I7-6600U	2.6 up to 3.4GHz	2 / 4	15W 25W	●	option
SBC-7114-3955U	Celeron 3955U	2.0GHz	2 / 2	15W	●	option
SBC-7114-3955UP	Celeron 3955U	2.0GHz	2 / 2	15W	●	option
SBC-7114-3965U	Celeron 3965U	2.2GHz	2 / 2	15W	●	option
SBC-7114-3965UP	Celeron 3965U	2.2GHz	2 / 2	15W	●	option
SBC-7114-I3-7100U	I3-7100U	2.40GHz	2 / 4	15W	●	
SBC-7114-I3-7100UP	I3-7100U	2.40GHz	2 / 4	15W	●	option
SBC-7114-I5-7300U	I5-7300	2.6 up to 3.5GHz	2 / 4	15W 25W	●	option
SBC-7114-I5-7300UP	I5-7300	2.6 up to 3.5GHz	2 / 4	15W 25W	●	option
SBC-7114-I7-7600U	I7-7600U	2.8 up to 3.9GHz	2 / 4	15W 25W	●	option
SBC-7114-I7-7600UP	I7-7600U	2.8 up to 3.9GHz	2 / 4	15W 25W	●	option

2. H1/H2/H3/H4 (option):

CPU1 Heat Sink Screw holes, four screw holes for Intel Skylake-U/ Kaby Lake Processors.

Heat Sink assemblies.

3. FAN1:

(2.54mm Pitch 1x3 Pin Header), Fan connector, cooling fans can be connected directly for use. You may set the rotation condition of cooling fan in menu of BIOS CMOS Setup.

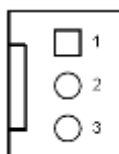

Pin#	Signal Name
1	Ground
2	VCC
3	Rotation detection



Note:

Output power of cooling fan must be limited under 5W.

4. DDR4_1:

(SO-DIMM 260Pin socket), DDR4 memory socket, the socket is located at the top of the board and supports 260Pin 1.2V DDR4 2133MHz FSB SO-DIMM memory module up to [16GB](#).

Model	DDR4 Memory Types (FSB)
SBC-7114-I3-6100U/P	2133 MHz
SBC-7114-I5-6300U/P	2133 MHz
SBC-7114-I7-6600U/P	2133 MHz
SBC-7114-3955U/P	1866 / 2133 MHz
SBC-7114-3965U/P	2133 MHz
SBC-7114-I3-7100U/P	2133 MHz
SBC-7114-I5-7300U/P	2133 MHz
SBC-7114-I7-7600U/P	2133 MHz

5. BAT3 :

(1.25mm Pitch 1x2 Wafer Pin Header, SMD) 3.0V Li battery is embedded to provide power for CMOS. CMOS clear operation will permanently reset old BIOS settings to factory defaults.

Pin#	Signal Name
Pin1	Ground
PIN2	VBAT



Procedures of CMOS clear:

- a) Turn off the system and unplug the power cord from the power outlet.
- b) Remove the lithium battery connection from BAT3 for 10 seconds, and then connect it.
- c) Power on the system again.
- d) When entering the POST screen, press the <ESC> or key to enter CMOS Setup Utility to load optimal defaults.
- e) After the above operations, save changes and exit BIOS Setup.

6. S_1 (PIN1):

(Switch), ATX Power and Auto Power on jumper setting.

S-1(Switch)	Mode
Pin1 (Off)	ATX Power
Pin1 (On)	Auto Power on (Default)

7. BAT2:

(2.0mm Pitch 1x10 Wafer Pin Header), smart battery Interface

Pin#	Signal Name
Pin1	VCC_BAT1
Pin2	VCC_BAT1
Pin3	VCC_BAT1
Pin4	SMB_DAT_SW
Pin5	SMB_CLK_SW
Pin6	BAT1_TEMP
Pin7	Ground
Pin8	Ground
Pin9	Ground
Pin10	SET_BAT1_ON

Function	Specifications
Nominal voltage (3S1P)	11.1~12.6V
Charge voltage	12.6V
Charge current	0.5C

8. J_POE1:

(2.0mm Pitch 1x2 Wafer Pin Header), POE or DCIN input setting.

J_POE1 (Jumper)	DC_IN1	BAT2
Pin1-Pin2(open, Default)	●	-
Pin1-Pin2 (Close)	-	●

9. BAT_LED1:

(2.0mm Pitch 1x4 Wafer Pin Header), The Charge status indicator for BAT2

Pin1-Pin3: Charge LED status.

Pin2-Pin3: Discharge LED status.

Pin4-Pin3: This is reserved for LVDS MCU IC reset.

Pin#	Signal Name
Pin1	BAT1_LED+
Pin2	BAT1_LED-
Pin3	Ground
Pin4	SBW_TDIO_RST (option)

10. DC_IN1:

(5.08mm Pitch 1x3 Pin Connector), DC 9V~36V System power input connector.

Pin#	Power Input
Pin1	DC_IN+ (DC+9V~36V)
Pin2	DC_IN- (Ground)
Pin3	FG

Model	DC_IN1
SBC-7114-I3-6100U	180°Connector
SBC-7114-I5-6300U	180°Connector
SBC-7114-I7-6600U	180°Connector
SBC-7114-3955U	180°Connector
SBC-7114-3965U	180°Connector
SBC-7114-I3-7100U	180°Connector
SBC-7114-I5-7300U	180°Connector
SBC-7114-I7-7600U	180°Connector
SBC-7114-I3-6100UP	45°Connector

SBC-7114-I5-6300UP	45°Connector
SBC-7114-I7-6600UP	45°Connector
SBC-7114-3955UP	45°Connector
SBC-7114-3965UP	45°Connector
SBC-7114-I3-7100UP	45°Connector
SBC-7114-I5-7300UP	45°Connector
SBC-7114-I7-7600UP	45°Connector

Connector	Power input
DC_IN1 (Default)	DC_IN1
BAT2 (option)	BAT2
DC_IN1 + BAT2 (option)	DC_IN1

11. P_SW1/BT1,BT2 :

Power on/off button, it is used to connect power switch button. The two pins are disconnected under normal condition. You may short them temporarily to realize system startup & shutdown or awaken the system from sleep state. P_SW1 or BT1 need to be selected before manufacturing.

(2.0mm Pitch 1x2 Wafer Pin Header), Power on/off button, it is used to connect power switch button.

P_SW1 or BT1	Function
BT1 (1x2Pin connect)	(Default)
P_SW1 (Button)	option
BT2	Function
BT1 (1x2Pin connect)	(Default)

12. LED2/LED3/LED4/LED5/LED6/LED7/LED8:

LED2: LED STATUS. Green LED for 3P3V_ALLS_EC Power status.

LED3: LED STATUS. Green LED for 3P3V_S5 Power status.

LED4: LED STATUS. Green LED for Motherboard Standby Power Good status.

LED5: LED STATUS. Reserve

LED6: LED STATUS. Green LED for charge status.

LED7: LED STATUS. Green LED for charge Complete status.

LED8: LED STATUS. Green LED for charge Power Good status.

13. S_1(PIN3/PIN4/PIN6):

(Switch), LVDS jumper setting.

S-1(Switch)	Function (CN1)
Pin3 (ON)	Single channel LVDS
Pin3 (OFF)	Dual channel LVDS (Default)
Pin4 (ON)	8/24 bit (Default)
Pin4 (OFF)	6/18 bit
SEL-LCD-EDID (U17 or OPC-547 U2/U3)	
Pin6 (ON)	Onboard EDID
Pin6 (OFF)	Panel EDID

14. U17:

AT24C02-DIP8,The EEPROM IC (U17) is the set of LVDS resolution.

If you need other resolution settings, please upgrade U17 data.

Model	LVDS resolution
SBC-7114-I3-6100U/P	1280*1024 (Default)
SBC-7114-I5-6300U/P	800*480 (option)
SBC-7114-I7-6600U/P	800*600 (option)
SBC-7114-I3-7100U/P	1024*768 (option)
SBC-7114-I5-7300U/P	1920*1080 (option)
SBC-7114-I7-7600U/P	
SBC-7114-3955U/P
SBC-7114-3965U/P	

15. INVT1:

(2.0mm Pitch 1x6 wafer Pin Header), Backlight control connector for LVDS

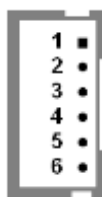

Pin#	Signal Name
1	+DC12V_S0
2	+DC12V_S0
3	Ground
4	Ground
5	BKLT_EN_OUT
6	BKLT_CTRL

16. CN1:

(1.25mm Pitch 2x20 Connector, DF13-40P), For 18/24-bit LVDS output connector, fully supported by Parad PS8625 (DP to LVDS), the interface features dual channel 24-bit output. Low Voltage Differential Signaling, A high speed, low power data transmission standard used for display connections to LCD panels.

Function	Signal Name	Pin#		Signal Name	Function
LVDS	12V_S0	2	1	12V_S0	LVDS
	BKLT_EN_OUT	4	3	BKLT_CTRL	
	Ground	6	5	Ground	
	LVDS_VDD5	8	7	LVDS_VDD5	
	LVDS_VDD3	10	9	LVDS_VDD3	
	Ground	12	11	Ground	
	LA_D0_P	14	13	LA_D0_N	
	LA_D1_P	16	15	LA_D1_N	
	LA_D2_P	18	17	LA_D2_N	
	LA_D3_P	20	19	LA_D3_N	
	LA_CLKP	22	21	LA_CLKN	
	LB_D0_P	24	23	LB_D0_N	
	LB_D1_P	26	25	LB_D1_N	
	LB_D2_P	28	27	LB_D2_N	
USB7 (option)	Ground	34	33	LCD_EDID_SEN	
	USB7_P	36	35	USB7_N	
	5V_S5_USB	38	37	LVDS1_DDC_DATA	
Power LED	PWR_LED+	40	39	LVDS1_DDC_CLK	

17. HDMI1:

(HDMI 19P Connector), HDMI 1.4P Port. High Definition Multimedia Interface connector



18. DP1 (option):

(1.25mm Pitch 2x20 Connector, DF13-40P), For DP Signal output connector, it can connect to TB-540A, a DP to VGA board.

Function	Signal Name	Pin#		Signal Name	Function	
EDP	12V_S0	2	1	12V_S0	EDP	
	12V_S0	4	3	12V_S0		
	Ground	6	5	Ground		
	5V_S0	8	7	5V_S0		
	3P3V_S0	10	9	3P3V_S0		
	CPU_CFG4	12	11	Ground		
	NC	14	13	DDI1_TX1_N		
	NC	16	15	DDI1_TX1_P		
	NC	18	17	Ground		
	DDI1_TX2_N	20	19	DDI1_TX0_N		
	DDI1_TX2_P	22	21	DDI1_TX0_P		
	Ground	24	23	Ground		
	DDI_TX3_N	26	25	DDI1_AUX_N		
	DDI_TX3_P	28	27	DDI1_AUX_P		
	NC	30	29	I2C1_SCL		I2C
	EDP_HP_CN	32	31	I2C1_SDA		
USB7 (option)	Ground	34	33	Ground	USB7 (option)	
	USB7_P	36	35	USB7_N		
	5V_S5_USB	38	37	5V_S5_USB		
Power LED	PWR_LED+	40	39	Ground	Power LED	

19. JP3/S_1(PIN5):

(2.0mm Pitch 2x2 wafer Pin Header), touch jumper setting.

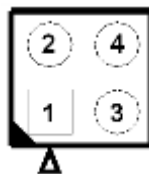

JP3	Touch(TCH1)
Open 3-4(default)	Enable
Close 3-4(option)	Disable
Open 1-2(default)	-

Priority Order :			
Touch Function	JP3(3-4)	S_1(Pin5)	EC_GPIO
TCH1(Enable)	Short	-	-

TCH1(Disable)	Open	ON	-
TCH1(Enable)	Open	OFF	1 (Default)
TCH1(Disable)	Open	OFF	0

20. TCH1:

(2.0mm Pitch 1x6 wafer Pin Header), internal touch controller connector.

Pin#	Signal Name
1	SENSE
2	X+
3	X-
4	Y+
5	Y-
6	GND_EARCH

21. LED1:

LED1: LED STATUS. Green LED for touch power status.

22. JP1:

(2.0mm Pitch 2x3 Pin Header), COM1 jumper setting, pin 1~6 are used to select signal out of pin 9 of COM1 port.

JP1 Pin#	Function
Close 1-2	COM1 RI (Ring Indicator) (default)
Close 3-4	COM1 Pin9:DC+5V (option)
Close 5-6	COM1 Pin9:DC+12V (option)

23. COM1:

(Type **DB9M**),Rear serial port, standard DB9 Male serial port is provided to make a direct connection to serial devices. COM1 port is controlled by pins No.1~6 of JP1, select output Signal RI or 5V or 12V, for details, please refer to description of JP1 and S_232 and S_422 setting.

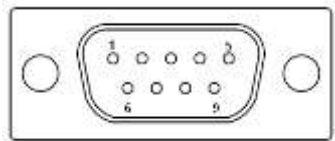

RS232 (Default):	
Pin#	Signal Name
1	DCD# (Data Carrier Detect)
2	RXD (Received Data)
3	TXD (Transmit Data)
4	DTR (Data Terminal Ready)
5	Ground
6	DSR (Data Set Ready)
7	RTS (Request To Send)
8	CTS (Clear To Send)
9	JP1 select Setting (R1/5V/12V)
BIOS Setup : Advanced/NCT6106D Super IO Configuration/F75111 COM1 Configuration 【RS-232】	

RS422 (option):	
Pin#	Signal Name
1	422_TX-
2	422_TX+
3	422_RX+
4	422_RX-
5	Ground
6	NC
7	NC
8	NC
9	NC
BIOS Setup : Advanced/NCT6106D Super IO Configuration/F75111 COM1 Configuration 【RS-422】	

RS485 (option):	
Pin#	Signal Name
1	485-
2	485+
3	NC
4	NC
5	Ground

6	NC
7	NC
8	NC
9	NC
BIOS Setup : Advanced/NCT6106D Super IO Configuration/F75111 COM1 Configuration 【RS-485】	

24. JP2:

(2.0mm Pitch 2x3 Pin Header), COM2 jumper setting, pin 1~6 are used to select signal out of pin 9 of COM2 port.

JP2 Pin#	Function
Close 1-2	COM2 RI (Ring Indicator) (default)
Close 3-4	COM2 Pin9 : DC+5V (option)
Close 5-6	COM2 Pin9 : DC+12V (option)

25. COM2:

(Type DB9M), Rear serial port, standard DB9 Male serial port is provided to make a direct connection to serial devices.

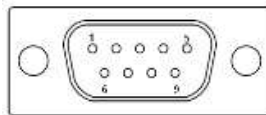

Pin#	Signal Name
1	DCD# (Data Carrier Detect)
2	RXD (Received Data)
3	TXD (Transmit Data)
4	DTR (Data Terminal Ready)
5	Ground
6	DSR (Data Set Ready)
7	RTS (Request To Send)
8	CTS (Clear To Send)
9	JP2 select Setting (RI/5V/12V)

26. SATA_P1:

(2.5mm Pitch 1x2 box Pin Header), One onboard 5V output connector is reserved to provide power for SATA devices.

Pin#	Signal Name
1	5V_S0 (+DC5V output)
2	Ground



Note:

Output current of the connector must not be above 1A.

27. SATA2:

(SATA 7Pin), SATA Connectors, one SATA connector is provided with transfer speed up to 6.0 Gb/s.

28. SATA1:

(SATA 7Pin+15Pin), SATA Connectors, one SATA connector is provided; with transfer speed up to 6.0Gb/s.

29. S_1(PIN2):

(Switch), MSATA Signal and PCIE Signal jumper setting for MPCIE1.

S-1 (Switch)	MPCIE1
Pin2 (Off)	MSATA Signal (option)
Pin2 (On)	PCIE Signal (Default)

30. MPCIE1:

(50.95mmx30mm Socket 52Pin), mSATA socket, it is located at the top, it supports mini PCIe devices with LPCbus and SMbus and mSATA signal. **B2 mSATA bus** for flash disk signal.

Function	Support
Mini SATA	●(Default, S_1 setting)
Mini PCie	○(Option, S_1 setting)
LPC bus	●
SMbus	●
USB2.0 (USB6)	●

31. H5/H6:

MPCIE1 SCREW HOLES, H5 and H6 for mini PCIE card (30mmx50.95mm) assemble.

32. AUDIO2:

(2.0mm Pitch 2X6 Pin Header), Front Audio, An onboard Realtek ALC269Q codec is used to provide high-quality audio I/O ports. Line Out can be connected to a headphone or amplifier. Line In is used for the connection of external audio source via a Line in cable. MIC is the port for microphone input audio.

Signal Name	Pin#	Pin#	Signal Name
+5V_F_AUDIO	1	2	GND_AUD
LINE-OUT-L	3	4	LINE-OUT-R
FRONT_JD	5	6	LINE_IN_JD
LINE-IN-L	7	8	LINE-IN-R
MIC-IN-L	9	10	MIC-IN-R
GND_AUD	11	12	MIC1_JD

33. LINE_OUT:

(Diameter 3.5mm Jack), HD Audio port, An onboard Realtek ALC269Q codec is used to provide high quality audio I/O ports. Line Out can be connected to a headphone or amplifier.



34. SPK1:

(2.0mm Pitch 1x4 Wafer Pin Header), support a stereo Class-D Speaker Amplifier with 2 watt per channel output power

Pin#	Signal Name
1	SPK_OUTL_P
2	SPK_OUTL_N
3	SPK_OUTR_N
4	SPK_OUTR_P

35. USB1:

USB3-1/USB3-2 : (Double stack USB type A), Rear USB connector, it provides up to two USB3.0 ports, High-speed USB 2.0 allows data transfers up to 480 Mb/s, USB 3.0 allows data transfers up to 5.0Gb/s ,support USB full-speed and low-speed signaling.

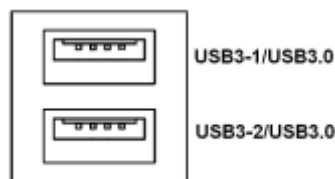

Each USB Type A Receptacle (2 Ports) Current limited value is 2.0A.

If the external USB device current exceeds 1.5A, please separate connectors into different Receptacle.

36. LAN1/LAN2:

LAN1/LAN2: (RJ45 Connector), Rear LAN port, Two standard 10/100/1000M RJ-45 Ethernet ports are provided. Use Intel 82574L chipset, LINK LED (green) and ACTIVE LED (green) respectively located at the left-hand and right-hand side of the Ethernet port indicate the activity and transmission state of LAN.



37. BUZ1:

Onboard buzzer

38. CN2:

(DF13-30P Connector), for expand output connector, it provides eight GPIO, two RS422 or RS485, one USB2.0, one Power on/off, one Reset.

Function	Signal Name	Pin#	Signal Name	Function	
5V	5V_S5	2	1	5V_S5	5V
6106_GPIO41	GPIO_IN2	4	3	GPIO_IN1	6106_GPIO40
6106_GPIO43	GPIO_IN4	6	5	GPIO_IN3	6106_GPIO42
6106_GPIO45	GPIO_OUT2	8	7	GPIO_OUT1	6106_GPIO44
6106_GPIO47	GPIO_OUT4	10	9	GPIO_OUT3	6106_GPIO46
	Ground	12	11	Ground	
485 or 422 (COM5)	485+_422TX5+	14	13	485-_422TX5-	485 or 422 (COM5)
	422_RX5+	16	15	422_RX5-	
485 or 422 (COM6)	485+_422TX6+	18	17	485-_422TX6-	485 or 422 (COM6)
	422_RX6+	20	19	422_RX6-	
5V	5V_S0	22	21	HDD_LED+	HDD LED
USB2.0	5V_USB5	24	23	5V_USB5	USB2.0
	USB5_P	26	25	USB5_N	
	Ground	28	27	FP_RST-	RESET
Power auto on	PWRBTN_ON	30	29	Ground	
COM5 BIOS Setup : Advanced/NCT6106D Super IO Configuration/ COM5 Configuration 【RS-422】 Advanced/NCT6106D Super IO Configuration/ COM5 Configuration 【RS-485】 COM6 BIOS Setup : Advanced/NCT6106D Super IO Configuration/ COM5 Configuration 【RS-422】 Advanced/NCT6106D Super IO Configuration/ COM5 Configuration 【RS-485】					

39. EC_GPIO1 :

(2.0mm Pitch 1X10 Pin Header),For expand connector ,It provides eight GPIO.

Pin#	Signal Name	GPIO Name
1	Ground	Ground
2	GPA0_ONOFF	EC_GPA0
3	GPA1_SPK	EC_GPA1
4	GPE6_BKLT	EC_GPE6
5	GPE0_BKLT+	EC_GPE0
6	GPH3_SPK+	EC_GPH3
7	BKLT_CTRL_PWR	BKLT_CTRL_PWR
8	ADC6_BKLT_CTRL	EC_ADC6
9	ADC7_RSV	EC_ADC7
10	3.3V_ALLS_EC	3.3V_ALLS_EC

40. CN3:

(1.27mm Pitch 2X50 Female Header),for expand output connector, it provides four GPIO, two USB 2.0,two PS/2 for keyboard and mouse(currently not support), two uart, one PClex1,one SMbus, two PClex1 or USB3.0, two USB 2.0, connected to the TB-528 riser Card.

Function	Signal Name	Pin#		Signal Name	Function
	5V_S5_USB	1	2	5V_S5_USB	
	5V_S5_USB	3	4	5V_S5_USB	
	USB3489_OC	5	6	PSON_ALL-	
USB4	USB4_N	7	8	USB4_P	USB4
USB3	USB3_N	9	10	USB3_P	USB3
	Ground	11	12	Ground	
Not support	PS2_MSCLK	13	14	PS2_MSDATA	Not Support
	PS2_KBCLK	15	16	PS2_KBDATA	
COM4 (UART)	COM4_RI	17	18	COM4_DCD-	COM4 (UART)
	COM4_TXD	19	20	COM4_RXD	
	COM4_DTR	21	22	COM4_RTS-	
	COM4_DSR	23	24	COM4_CTS-	
	Ground	25	26	Ground	
COM3	COM3_RI	27	28	COM3_DCD-	COM3
	COM3_TXD	29	30	COM3_RXD	

(UART)	COM3_DTR	31	32	COM3_RTS-	(UART)
	COM3_DSR	33	34	COM3_CTS-	
GPPC20	PCH_GPPC20	35	36	PCH_GPPC22	GPPC22
GPPC21	PCH_GPPC21	37	38	PCH_GPPC23	GPPC23
	Ground	39	40	Ground	
PCIE4	PCIE4_TX_NO	41	42	PE4_TX_PO	PCIE1
	PCIE4_RX_NO	43	44	PE4_RX_PO	
	Ground	45	46	Ground	
	CLK_100M_PE4_N	47	48	CLK_100M_PE4_P	
	PCIE4_WAKE_N	49	50	PLT_RST_BUF2-	
SMBUS	SMB_CLK_S5	51	52	SMB_DATA_S5	SMBUS
PCIE	CLKREQ_PE4-	53	54	Ground	
	3P3V_S5	55	56	PWRBTN_ON-	Power Auto on
	3P3V_S5	57	58	3P3V_S5	
12V	12V_S0	59	60	12V_S0	12V
12V	12V_S0	61	62	12V_S0	12V
PCIE3	Ground	63	64	Ground	PCIE3
	PE3_TX_NO	65	66	PE3_TX_PO	
	PE3_RX_NO	67	68	PE3_RX_PO	
	Ground	69	70	Ground	
	CLK_100M_PE0_N	71	72	CLK_100M_PE0_P	
	CLKREQ_PE0-	73	74	CLKREQ_PE5-	
PCIE5 or USB3.0	Ground	75	76	Ground	PCIE5 or USB3.0
	CLK_100M_PE5_N	77	78	CLK_100M_PE5_P	
	USB5PE1_TX_N	79	80	USB5PE1_TX_P	
	USB5PE1_RX_N	81	82	USB5PE1_RX_P	
PCIE6 or USB3.0	Ground	83	84	Ground	PCIE6 or USB3.0
	USB6PE2_TX_N	85	86	USB6PE2_TX_P	
	USB6PE2_RX_N	87	88	USB6PE2_RX_P	
	CLK_100M_XDP_N	89	90	CLK_100M_XDP_P	
USB2.0	Ground	91	92	Ground	USB2.0
	USB8_N	93	94	USB8_P	
	USB9_N	95	96	USB9_P	
	5V_S5	97	98	5V_S5	
	3P3V_S5	99	100	3P3V_S5	

41. TPM_U1 (option) :

Infineon's Trusted Platform Module (TPM2.0) SLB9665 is a fully standard compliant TPM based on the latest Trusted Computing Group (TCG) specification 2.0.

Note: Only support Windows 10 IOT

TPM_U1	SLB 9665 TT2.0
MODEL	TPM Function
SBC-7114-XXX R2.30	●
SBC-7114-XXX R2.20	X
SBC-7114-XXX R1XX	X

42. TB-528 series:

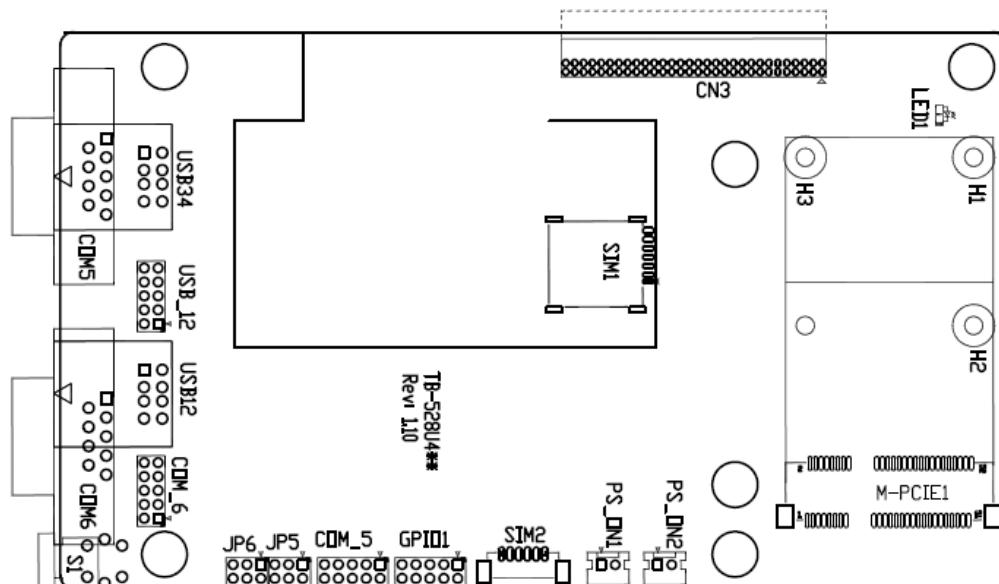

No.	Model	CN3 2*30P	S1	USB12 TypeA	USB34 TypeA	USB_12 2*5P	COM5 DB9	COM6 DB9	COM_5 2*5P	COM_6 2*5P	JP5 2*3P	JP6 2*3P	GPIO 2*5P	SIM1 Socket	SIM2 1*6P	M_PCIE1 52P	PS_ON1 1*2P	PS_ON2 1*2P
1	TB-528U4C2ME1P1 R110	●	●	●	●	●	●	●	●	●	●	●	●	●	●	●	●	●
2	TB-528U4ME1 R110	●	●	●	●	○	○	○	○	○	○	○	●	●	○	●	●	●
3	TB-528U4 R110	●	○	●	●	○	○	○	○	○	○	○	○	○	○	○	○	○
4	TB-528C1U2P1 R110	●	●	●	○	○	●	○	○	○	●	○	●	○	○	○	●	●
5	TB-528C1U2 R110	●	○	●	○	○	●	○	○	○	○	○	●	○	○	○	●	●
6	TB-528C2ME1 R110	●	○	○	○	○	●	●	○	○	●	●	●	○	○	●	●	●
7	TB-528C2 R110	●	○	○	○	○	●	●	○	○	●	●	○	○	○	○	○	○

CN3 :

(1.27mm Pitch 2X30 Pin Header), connect to SBC-7114 CN2 pin Header.

M-PCIE1 :

(Socket 52Pin), mini PCIe socket, it is located at the top, it supports mini PCIe devices with **USB2.0 (USB3)**, Smbus, SIM and PCIe signal. MPCIE card size is 30x30mm or 30x50.95mm.

Signal Name	Function support
PCIe 1X	Yes
USB2.0 (USB2)	Yes
SMBus	Yes
SIM	Yes

H1/H2:

MPCIE1 SCREW HOLES, H2 for mini PCIE card (30mmx30mm) assemble. H1 for mini PCIE card (30mmx50.95mm) assemble.

LED1 :

Mini PCIe devices LED Status

SIM1 :

(SIM Socket 6 Pin), Support SIM Card devices

SIM2 (option) :

(1.25mm Pitch 1X6 Pin Wafer), for SIM card devices' expansion

GPIO1 :

(2.0mm Pitch 2x5 Pin Header), General-purpose input/output port, it provides a group of self-programming interfaces to customers for flexible use.

Signal Name	Pin#	Pin#	Signal Name
Ground	1	2	GPIO_OUT1
GPIO_OUT2	3	4	SMB_DATA_R
SMB_CLK_R	5	6	GPIO_IN1
GPIO_IN2	7	8	GPIO_IN3
GPIO_IN4	9	10	+5V

USB12/USB34(USB-HUB) :

(Double stack USB type A), rear USB connector, it provides up to 4 USB 2.0 ports, speed up to 480Mb/s.



USB_12:

(2.0mm Pitch 2x5 Pin Header), front USB connector, it provides two USB ports via a dedicated USB cable, speed up to 480Mb/s.

Signal Name	Pin#	Pin#	Signal Name
5V_USB12	1	2	5V_USB12
E_USB1_N	3	4	E_USB2_N
E_USB1_P	5	6	E_USB2_P
Ground	7	8	Ground
NC	9	10	Ground



Note:

Before connection, make sure that pinout of the USB Cable is in accordance with that of the said tables. Any inconformity may cause system down and even hardware damages.

JP5 :

(2.0mm Pitch 2x3 Pin Header), COM5 setting jumper, pin 1~6 are used to select signal out of pin 9 of COM5 port.

JP5 Pin#	Function	
Close 1-2	RI (Ring Indicator)	(default)
Close 3-4	COM5 Pin9=+5V	(option)
Close 5-6	COM5 Pin9=+12V	(option)

COM5 :

(Type DB9), serial port, standard DB9 serial port is provided to make a direct connection to serial devices. COM5 port is controlled by pins No.1~6 of **JP5**, select output Signal RI or 5V or 12v, for details, please refer to description of JP3.

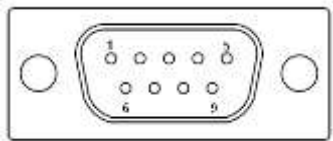

Pin#	Signal Name
1	DCD# (Data Carrier Detect)
2	RXD (Received Data)
3	TXD (Transmit Data)
4	DTR (Data Terminal Ready)
5	Ground
6	DSR (Data Set Ready)
7	RTS (Request To Send)

8	CTS (Clear To Send)
9	<p>JP5 Setting:</p> <p>Pin1-2 : RI (Ring Indicator) (default)</p> <p>Pin3-4 : 5V Standby power (option)</p> <p>Pin5-6:12V Standby power (option)</p>

COM_5:

(2.0mm Pitch 2x5 Pin Header), COM5 port, up to one standard RS232 port is provided. It can be used directly via COM cable connection.

Signal Name	Pin#	Pin#	Signal Name
DCD	1	2	RXD
TXD	3	4	DTR
Ground	5	6	DSR
RTS	7	8	CTS
JP6 setting: RI/5V/12V	9	10	NC

JP6 :

(2.0mm Pitch 2x3 Pin Header), COM6 setting jumper, pin 1~6 are used to select signal out of pin 9 of COM6 port.

JP6 Pin#	Function
Close 1-2	RI (Ring Indicator) (default)
Close 3-4	COM6 Pin9=+5V (option)
Close 5-6	COM6 Pin9=+12V (option)

COM6 :

(Type DB9), serial port, standard DB9 serial port is provided to make a direct connection to serial devices. COM6 port is controlled by pins No.1~6 of **JP6**, select output Signal RI or 5V or 12v, for details, please refer to description of JP6.

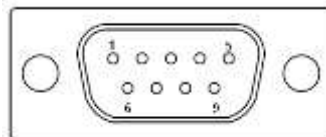

Pin#	Signal Name
1	DCD# (Data Carrier Detect)
2	RXD (Received Data)
3	TXD (Transmit Data)

4	DTR (Data Terminal Ready)
5	Ground
6	DSR (Data Set Ready)
7	RTS (Request To Send)
8	CTS (Clear To Send)
9	<p>JP6 Setting:</p> <p>Pin1-2 : RI (Ring Indicator) (default)</p> <p>Pin3-4 : 5V Standby power (option)</p> <p>Pin5-6:12V Standby power (option)</p>

COM_6:

(2.0mm Pitch 2X5 Pin Header), COM6 Port, up to one standard RS232 port is provided. It can be used directly via COM cable connection.

Signal Name	Pin#	Pin#	Signal Name
DCD	1	2	RXD
TXD	3	4	DTR
Ground	5	6	DSR
RTS	7	8	CTS
JP6 Setting: RI/5V/12V	9	10	NC

PS_ON1:

(2.0mm Pitch 1x2 Pin Wafer), ATX Power and Auto Power on jumper setting

PS_ON	Mode
Close 1-2	Auto Power on (default)
Close 1-2	ATX Power

PS_ON2 (option):

(2.0mm Pitch 1x2 Pin Wafer)

S1:

PWR BT: POWER on/off Button, it is used to connect power switch button. The two pins are disconnected under normal condition. You may short them temporarily to realize system startup & shutdown or awaken the system from sleep state.

PWR LED: POWER LED status.

43. TB-528CAN2 R2.00 (option) :

SBC-7114 Riser Card, TB-528CAN2 CN3 connect to SBC-7114 CN3 pin Header. It provides two CAN-bus interfaces.

TB-528CAN2 Top :

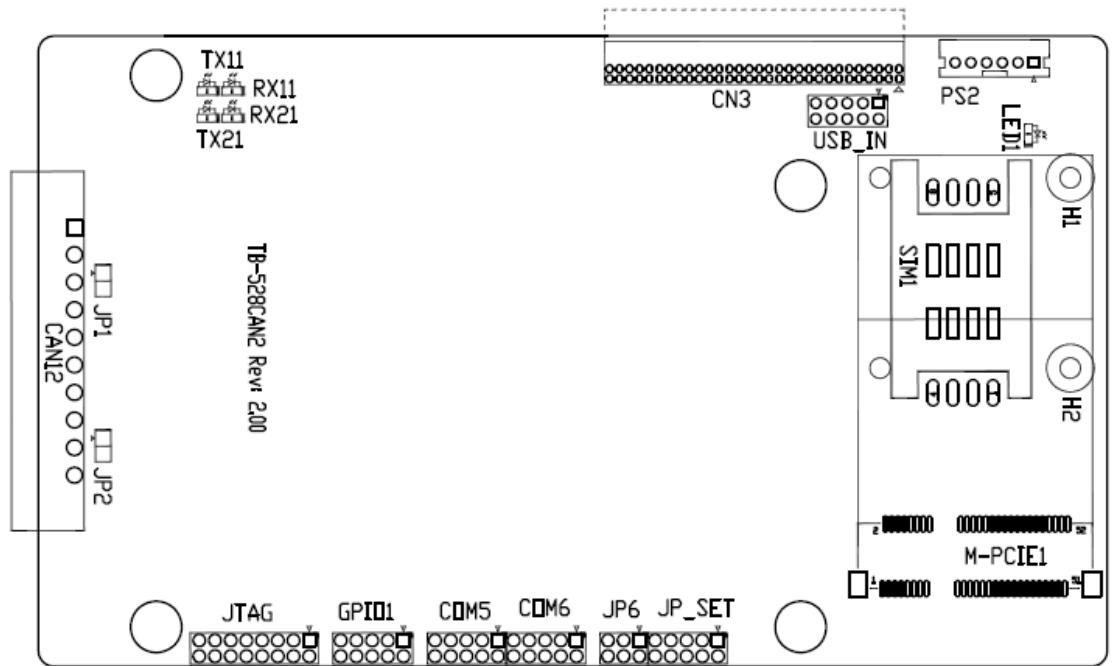

CN3 :

(1.27mm Pitch 2X30 Pin Header), connect to SBC-7114 CN3 pin Header.

M-PCIE1 :

(Socket 52Pin), mini PCIe socket, it is located at the top, it supports mini PCIe devices with SMBus, USB2.0, SIM and PCIe signal. MPCie card size is 30x30mm or 30x50.95mm.

Signal Name	Function support
PCIe 1x	Yes
USB2.0 (USB2)	Yes
SMBus	Yes
SIM	Yes

H1/H2 :

MPCIE1 SCREW HOLES, H2 for mini PCIE card (30mm x 30mm) assemble.
H1 for mini PCIE card (30mm x 50.95mm) assemble.

LED1 :

Mini PCIe devices LED status.

SIM1 (option) :

(SIM Socket 6 Pin), Support SIM Card devices.

PS2 :

(2.0mm Pitch 1x6 Pin Wafer), PS/2 keyboard and mouse port, the port can be connected to PS/2 keyboard or mouse via a dedicated cable for direct use.

Pin#	Signal Name
1	KBDATA
2	MSDATA
3	Ground
4	+5V
5	KBCLK
6	MSCLK

USB_IN (option) :

(2.0mm Pitch 2x5 Pin Header), Front USB connector, it provides two USB port via a dedicated USB cable, speed up to 480Mb/s.

Signal Name	Pin#	Pin#	Signal Name
5V_USB34	1	2	5V_USB34
NC (USB4_N)	3	4	NC (USB3_N)
NC (USB4_P)	5	6	NC (USB3_P)
Ground	7	8	Ground
NC	9	10	Ground



Note:

Before connection, make sure that pinout of the USB cable is in accordance with that of the said tables. Any inconformity may cause system down and even hardware damages.

JP_SET (option) :

(2.0mm Pitch 2x5 Pin Header)

Signal Name	Pin#	Pin#	Signal Name
3P3V_S5_USB	1	2	3P3V_S5
3P3V_S5_USB	3	4	3P3V_S5
3P3V_S5_USB	5	6	3P3V_S5
PSON_ATX	7	8	Ground

PSON_ATX	9	10	Ground
----------	---	----	--------

JP6 :

(2.0mm Pitch 2x3 Pin Header) COM6 setting jumper, pin1~6 are used to select signal out of pin9 of COM6 port.

JP6 Pin#	Function	
Close 1-2	RI (Ring Indicator)	(default)
Close 3-4	COM6 Pin9 : +5V	(option)
Close 5-6	COM6 Pin9 : +12V	(option)

COM6(SBC-7114/COM4) :

(2.0mm Pitch 2x3 Pin Header) COM6 port, up to one standard RS232 port is provided. It can be used directly via COM cable connection.

Signal Name	Pin#	Pin#	Signal Name
DCD	1	2	RXD
TXD	3	4	DTR
Ground	5	6	DSR
RTS	7	8	CTS
JP6 Setting: RI/5V/12V	9	10	NC

COM5 (SBC-7114/COM3) :

(2.0mm Pitch 2x5 Pin Header), COM5 Port, up to one standard RS232 port is provided. It can be used directly via COM cable connection.

Signal Name	Pin#	Pin#	Signal Name
DCD	1	2	RXD
TXD	3	4	DTR
Ground	5	6	DSR
RTS	7	8	CTS
JP6 Setting: RI/5V/12V	9	10	NC

GPI01:

(2.0mm Pitch 2x5 Pin Header), General-purpose input/output port, it provides a group of self-programming interfaces to customers for flexible use.

Signal Name	Pin#	Pin#	Signal Name
Ground	1	2	NC
NC	3	4	SMB_DATA_R

SMB_CLK_R	5	6	PCH-GPIO56
PCH-GPIO57	7	8	PCH-GPIO58
PCH-GPIO58	9	10	+5V

JTAG:

(2.0mm Pitch 2x5 Pin Header), Reserve

JP1:

(2.0mm Pitch 1x2 Pin Header), Reserve

JP2:

(2.0mm Pitch 1x2 Pin Header), Reserve

CAN1/CAN2:

(3.5mm Pitch 1x10 Pin connector), it provides two CAN-bus interfaces.

Pin#	Channel	Signal Name	Function
1	CAN2	CANL2	CAN bus Signal L
2		R2-	Terminal resistor R-(internally connected to CANL2)
3		FG	Shield cable (FG)
4		R2+	Terminal resistor R+(internally connected to CANH2)
5		CANH2	CAN bus Signal H
6	CAN1	CANL1	CAN bus Signal L
7		R1-	Terminal resistor R-(internally connected to CANL1)
8		FG	Shield cable (FG)
9		R1+	Terminal resistor R+(internally connected to CANH1)
10		CANH1	CAN bus Signal H

【 See TB-528CAN2 Manual 】

44. TB-528E1U2/TB528E1U2POE/TB-528E1U2UPOE:

SBC-7118 IO expansion card, provides USB2.0 and 1xGbE LAN expansion. It can support POE (Power on Ethernet) powered device via onboard POE module.

TB-528E1U2POE Top :

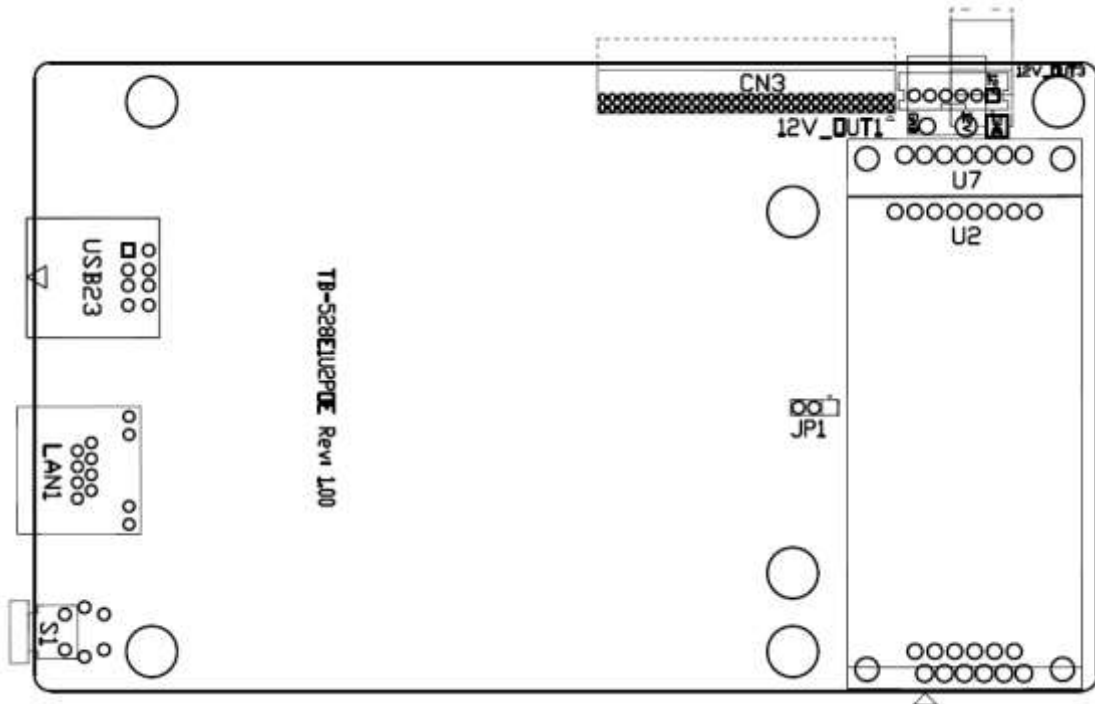

CN3 :

(1.27mm Pitch 2X30 Pin Header), connect to SBC-7118 CN2 pin Header.

USB23 (SBC-7114 USB3/USB4) :

(Double stack USB type A), Rear USB connector, it provides up to 2 USB2.0 ports, speed up to 480Mb/s.



LAN1:

(RJ45 Connector), Rear LAN port, one standard 10/100/1000M RJ-45 Ethernet port is provided. Use Intel I211-AT chipset, LINK LED (green) and ACTIVE LED (green) respectively located at the left-hand side of the Ethernet port indicate the activity and transmission state of LAN.

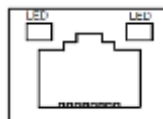

PSE Function support	
PSE output voltage	DC44-57V

U2/U7 (option) :

For onboard POE powered device module.

12V_OUT1 :

(3.96mm Pitch 1x2 Pin Header), POE DC 12V Output.

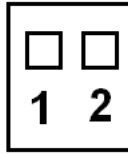

Pin#	Output Voltage
1	12V_POE
2	Ground

Model	U7	Maximum Output Power	SBC-7114
TB-528E1UPOE	AG5510	40W	●

12V_OUT3 (option):

(2.0mm Pitch 1x6 Pin Header), Reserve

12V_OUT1 (option):

(3.96mm Pitch 1x2 Pin Header), Reserve

JP3 (option):

(2.0mm Pitch 1x3 Pin Header), Reserve

S1 (option): Reserve

45. TB-548 R1.00 (option) :

SBC-7114 Riser Card, TB-548 LVDS1 connects to SBC-7114 CN1 DF13-40P, TB-548 INVT1 connects to SBC-7114 INVT1, TB-548 TCH1 connects to SBC-7114 TCH1, TB-548 CON1 connects to TB-547 CON1.

TB-548 Top :

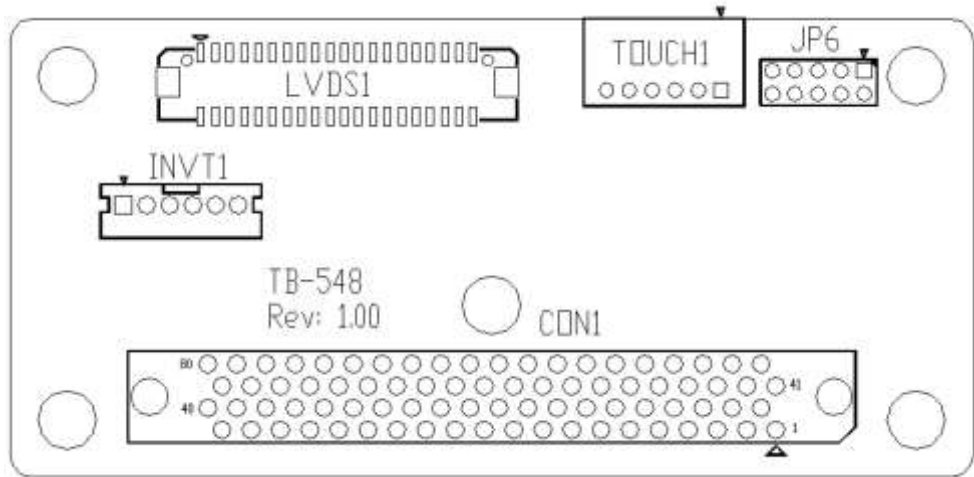

LVDS1 :

(1.25mm Pitch 2X20 connector, DF13-40P)

Function	Signal Name	Pin#		Signal Name	Function
LVDS	12V_S0	2	1	12V_S0	LVDS
	BKLT_EN_OUT	4	3	BKLT_CTRL	
	Ground	6	5	Ground	
	LVDS_VDD5	8	7	LVDS_VDD5	
	LVDS_VDD3	10	9	LVDS_VDD3	
	Ground	12	11	Ground	
	LA_D0_P	14	13	LA_D0_N	
	LA_D1_P	16	15	LA_D1_N	
	LA_D2_P	18	17	LA_D2_N	
	LA_D3_P	20	19	LA_D3_N	
	LA_CLKP	22	21	LA_CLKN	
	LB_D0_P	24	23	LB_D0_N	
	LB_D1_P	26	25	LB_D1_N	
	LB_D2_P	28	27	LB_D2_N	
	LB_D3_P	30	29	LB_D3_N	
LB_CLKP	32	31	LB_CLKN		
USB7 (option)	Ground	34	33	SEL_LCD_EDID	
	USB7_P	36	35	USB7_N	
	5V_S5_USB	38	37	LVDS1_DDC_DATA	
Power LED	PWR_LED+	40	39	LVDS1_DDC_CLK	

INVT1 :

(2.0mm Pitch 1x6 wafer Pin Header), Backlight control connector for LVDS.

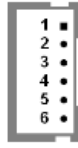

Pin#	Signal Name
1	+DC12V_S0
2	+DC12V_S0
3	Ground
4	Ground
5	BKLT_EN_OUT
6	BKLT_CTRL

TOUCH1 :

(2.0mm Pitch 1x6 wafer Pin Header), internal Touch controller connector.

Pin#	Signal Name
1	SENSE
2	X+
3	X-
4	Y+
5	Y-
6	GND_EARCH

JP6 (option) :

(2.0mm Pitch 2x5 Pin Header) LVDS EDID setting jumper

<i>JP6 Pin#</i>	<i>Function (CN1)</i>
<i>Close 1-2</i>	<i>Single channel LVDS</i>
<i>Open 1-2</i>	<i>Dual channel LVDS</i>
<i>Close 3-4</i>	<i>8/24 bit</i>
<i>Open 3-4</i>	<i>6/18 bit</i>
SEL-LCD-EDID:	
<i>Close 5-6</i>	<i>Onboard EDID</i>
<i>Open 5-6</i>	<i>Panel EDID</i>
All open (JP6)	Default

46. TB-547 R1.20 (option) :

TB-548 Riser Card, TB-547 LVDS1 connects to LVDS panel, TB-547 INVT1 connects to LVDS panel, TB-547 TOUCH1 connects to TOUCH panel, TB-547 CON1 OPS connects to TB-548 CON1.

TB-547 Top :

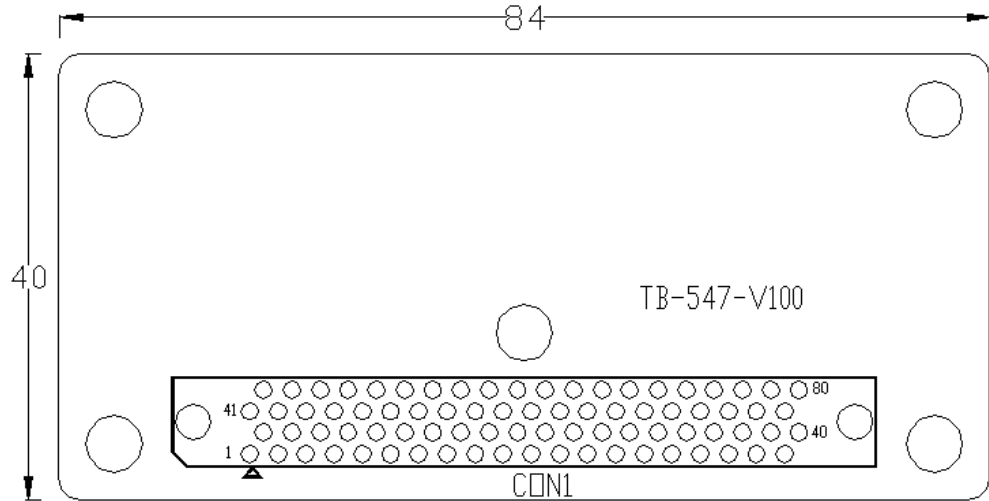

TB-547 Bottom:

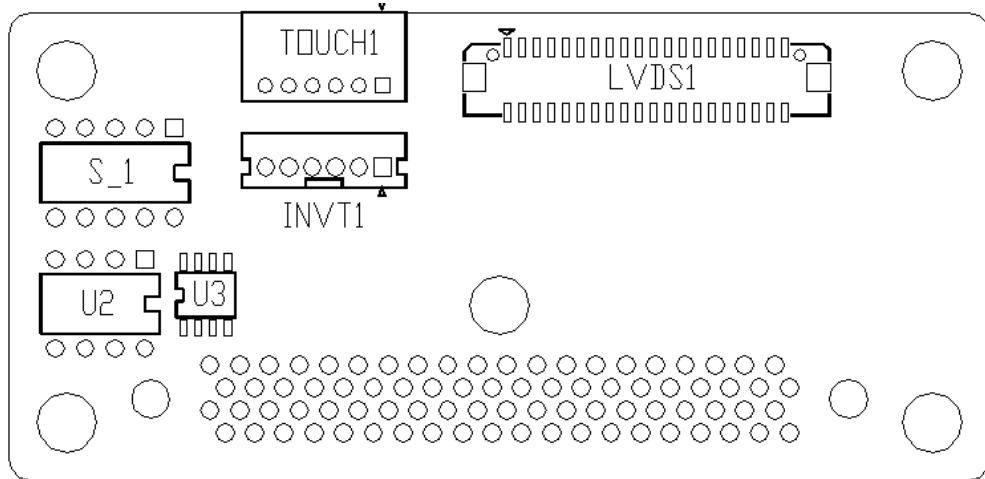

LVDS1 :

(1.25mm Pitch 2X20 connector, DF13-40P)

Function	Signal Name	Pin#		Signal Name	Function
	12V_S0	2	1	12V_S0	
	BKLT_EN_OUT	4	3	BKLT_CTRL	
	Ground	6	5	Ground	
	LVDS_VDD5	8	7	LVDS_VDD5	
	LVDS_VDD3	10	9	LVDS_VDD3	

LVDS	Ground	12	11	Ground	LVDS
	LA_D0_P	14	13	LA_D0_N	
	LA_D1_P	16	15	LA_D1_N	
	LA_D2_P	18	17	LA_D2_N	
	LA_D3_P	20	19	LA_D3_N	
	LA_CLKP	22	21	LA_CLKN	
	LB_D0_P	24	23	LB_D0_N	
	LB_D1_P	26	25	LB_D1_N	
	LB_D2_P	28	27	LB_D2_N	
	LB_D3_P	30	29	LB_D3_N	
	LB_CLKP	32	31	LB_CLKN	
	USB7 (option)	Ground	34	33	
USB7_P		36	35	USB7_N	
5V_S5_USB		38	37	5V_S5_USB	
Power LED	PWR_LED+	40	39	Ground	

INVT1 :

(2.0mm Pitch 1x6 wafer Pin Header), backlight control connector for LVDS.



Pin#	Signal Name
1	+DC12V_S0
2	+DC12V_S0
3	Ground
4	Ground
5	BKLT_EN_OUT
6	BKLT_CTRL

TCH1 :

(2.0mm Pitch 1x6 wafer Pin Header), internal Touch controller connector

Pin#	Signal Name
1	SENSE

2	X+
3	X-
4	Y+
5	Y-
6	GND_EARCH

S_1 (PIN3) :

(Switch), LVDS EDID setting jumper

S_1(Switch)	Function (LVDS)
Pin1 (ON)	Single channel LVDS
Pin1 (OFF)	Dual channel LVDS
Pin2 (ON)	8/24 bit
Pin2 (OFF)	6/18 bit
SEL-LCD-EDID (SBC-7114 U17 or OPC-547 U2/U3)	
Pin3 (ON)	Panel EDID
Pin3 (OFF)	Onboard EDID
Pin4	-
Pin5	-
This setting can only select SBC-7114 R2.XX S_1 or TB-547 S_1.	

U3:

AT24C02, The EEPROM IC (U3) is the set of LVDS resolution. If you need other resolution settings, please upgrade U3 data.

LVDS resolution	800*480 (option)
	800*600 (option)
	1024*768 (option)
	1280*1024 (option)
	1920*1080 (option)

3.1 Operations after POST Screen

After CMOS discharge or BIOS flashing operation, press [Delete] key to enter CMOS Setup.



After optimizing and exiting CMOS Setup

3.2 BIOS Setup Utility

Press [Delete] key to enter BIOS Setup utility during POST, and then a main menu containing system summary information will appear.

System Date:

Set the system date, the date format is:

Day: Note that the 'Day' automatically changes when you set the date.

Month: 01 to 12

Date: 01 to 31

Year: 1998 to 2099

3.4 Advanced Settings

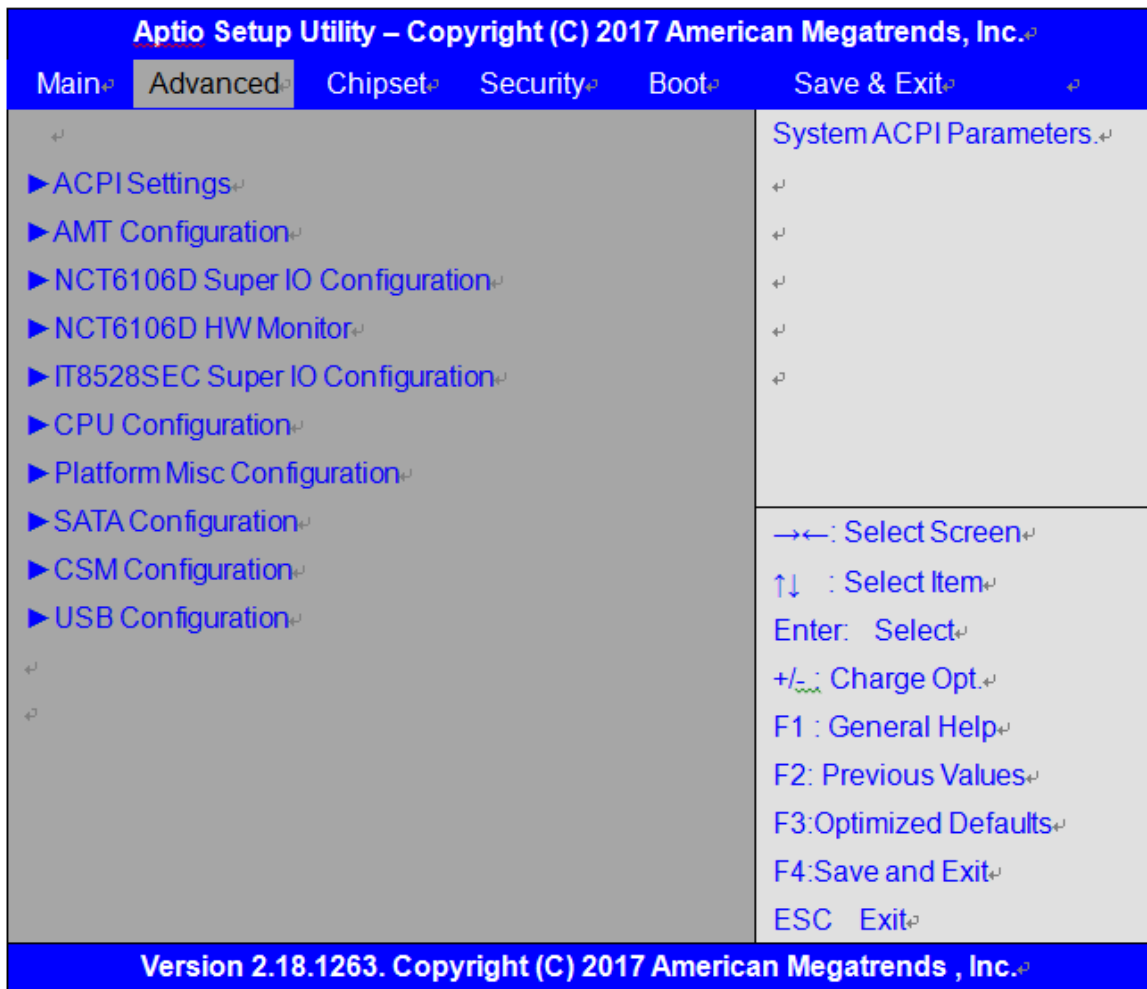

3.4.1 ACPI Settings

Enable ACPI Auto Configuration:

[Disabled]

[Enabled]

Enable Hibernation:

[Enabled]

[Disabled]

ACPI Sleep State:

[S3 (Suspend to RAM)]

[Suspend Disabled]

Lock Legacy Resources:

[Disabled]

[Enabled]

S3 Video Repost:

[Disabled]

[Enabled]

ACPI Low Power S0 Idle:

[Disabled]

[Enabled]

3.4.2 AMT Configuration

Intel AMT [Disabled]

BIOS Hotkey Pressed [Disabled]

MEBx Selection Screen [Disabled]

Hide Un-Configure ME Configuration [Disabled]

Prompt

MEBx Debug Message Output [Disabled]

Un-Configure ME [Disabled]

Amt Wait Timer 0

ASF [Enabled]

Activate Remote Assistance Process [Disabled]

USB Provisioning of AMT [Enabled]

PET Progress [Enabled]

AMT CIRA Timeout 0

WatchDog [Disabled]

OS Timer 0

BIOS Timer 0

3.4.3 NCT6106D Super IO Configuration

Super IO Chip NCT6106D

Serial Port 1 Configuration

Serial port [Enabled]

[Disabled]

Device Settings	IO=3F8h; IRQ=4;
Change Settings	[Auto]
F75111 COM1 Config	[RS-232 Mode] [RS-485 Mode] [RS-422 Mode]
Serial Port 2 Configuration	
Serial port	[Enabled] [Disabled]
Device Settings	IO=2F8h; IRQ=3;
Change Settings	[Auto]
Serial Port 3 Configuration	
Serial port	[Enabled] [Disabled]
Device Settings	IO=3E8h; IRQ=7;
Change Settings	[Auto]
Serial Port 4 Configuration	
Serial port	[Enabled] [Disabled]
Device Settings	IO=2E8h; IRQ=7;
Change Settings	[Auto]
Serial Port 5 Configuration	
Serial port	[Enabled] [Disabled]
Device Settings	IO=2F0h; IRQ=7;
Change Settings	[Auto]
COM5 Config	[RS-485 Mode] [RS-422 Mode]
Serial Port 6 Configuration	
Serial port	[Enabled] [Disabled]

Device Settings	IO=2E0h ; IRQ=7 ;
Change Settings	[Auto]
COM6 Config	[RS-485 Mode]
	[RS-422 Mode]
Power Failure	[Power OFF]
	[Power ON]
	[Last state]

3.4.4 NCT6106D HW Monitor

Pc Health Status	
CPU Temperature	: 38
CPU Fan Speed	: N/A
VCORE	: +0.872V
12V	: +11.864V
5V	: +5.299V
VCC3V	: +3.472V

3.4.5 IT8528SEC Super IO Configuration

EC VERSION	7114E005
Super IO Chip	IT8528SEC

3.4.6 CPU Configuration

Intel® Core™ i5-6200U CPU @ 2.30GHz	
CPU Signature	406E3
Microcode Patch	9E
Max CPU Speed	2300 MHz
Mix CPU Speed	400MHz
CPU Speed	2200 MHz
Processor Cores	2
Hyper Threading Technology	Supported
Intel VT-X Technology	Supported
Intel SMX Technology	Not Supported
64-bit	Supported
EIST Technology	Supported
CPU C3 state	Supported
CPU C6 state	Supported
CPU C7 state	Supported

CPU C8 state	Supported
CPU C9 state	Supported
CPU C10 state	Supported
L1 Data Cache	32KB x 2
L1 Code Cache	32KB x 2
L2 Cache	256 KB x 2
L3 Cache	3 MB
L4 Cache	Not Present

Hyper-threading	[Enabled]
Active Processor Cores	[All]
Overclocking lock	[Disabled]
Intel Virtualization Technology	[Enabled]
Hardware Prefetcher	[Enabled]
Adjacent Cache Line Prefetch	[Enabled]
CPU AES	[Enabled]
Boot performance mode	[Max Non-Turbo Performance]
Intel(R) Speed Shift Technology	[Enabled]
Intel(R) SpeedStep(tm)	[Enabled]
Turbo Mode	[Enabled]
Package Power Limit MSR Lock	[Disabled]
1-Core Ratio Limit Override	0
2-Core Ratio Limit Override	0
Configurable TDP Boot Mode	[Nominal]
Configurable TDP Lock	[Disabled]
CTDP BIOS control	[Disabled]
Platform PL1 Enable	[Disabled]
Platform PL2 Enable	[Disabled]
CPU C states	[Enabled]
Enhanced C-states	[Enabled]
C-State Auto Demotion	[C1 and C3]
C-State Un- Demotion	[C1 and C3]
Package C state demotion	[Enabled]
Package C state undemotion	[Enabled]
CState Pre-Wake	[Enabled]
Package C State limit	[AUTO]
CFG lock	[Enabled]

► **Power Limit 3 Settings**

Power Limit 3 Override [Disabled]

▶ **Power Limit 4 Settings**

Power Limit 4 Override [Disabled]

▶ **CPU Thermal Configuration**

CPU DTS [Disabled]

TCC Activation Offset 0

ACPI 3.0 T-States [Disabled]

Debug Interface [Disabled]

Debug Interface Lock [Enabled]

SW Guard Extensions(SGX) [Software Controlled]

Select Owner EPOCH input type [No Change In Owner EPOCHS]

PRMRR Size [AUTO]

3.4.7 Platform Misc Configuration

Native PCIE Enable [Enabled]

Native ASPM [Auto]

BDAT ACPI Table Support [Disabled]

Intel Ready Mode Technology [Disabled]

ACPI Debug [Disabled]

PTID Support [Enabled]

PECI Access Method [Direct I/O]

Firmware Configuration [Test]

ZpODD Support [Disabled]

PCI Delay Optimization [Disabled]

▶ **DPTF Configuration**

DPTF [Enabled]

▶ **Platform Setting**

Pmic Vcc IO Level [Disabled]

Pmic Vddq Level	[Disabled]
Power Sharing Manager	[Disabled]
Select Camera	[IVCAM]
Enable 3D Camera DFU device	[Disabled]
Wireless device	[Disabled]
WRDS Package	
WiFi SAR	[Disabled]
HID Event Filter Driver	[Disabled]
Enable Wireless Charge Support	[Disabled]
Enable FFU Support	[Disabled]

3.4.8 SATA Configuration

SATA Controller(S)	[Enabled]
SATA Mode	[AHCI]
SATA Test Mode	[Disabled]

► Software Feature Mask SATA Controller

Aggressive LPM Support	[Enabled]
SATA Controller Speed	[Default]

Serial ATA Port 0	Empty
Software Preserve	Unknown
Port 0	[Enabled]
Hot Plug	[Disabled]
External SATA	[Disabled]
Spin Up Device	[Disabled]
SATA Device Type	[Hard Disk Drive]
Topology	[Unknown]
Device Sleep	[Disabled]
SATA DEVSLEP Idle Timeout Config	[Disabled]

Serial ATA Port 1	Empty
Software Preserve	Unknown
Port 1	[Enabled]
Hot Plug	[Disabled]
External SATA	[Disabled]
Spin Up Device	[Disabled]
SATA Device Type	[Hard Disk Drive]

Topology	[Unknown]
Device Sleep	[Disabled]
SATA DEVSLEP Idle Timeout Config	[Disabled]
Serial ATA Port 2	Empty
Software Preserve	Unknown
Port 2	[Enabled]
Hot Plug	[Disabled]
External SATA	[Disabled]
Spin Up Device	[Disabled]
SATA Device Type	[Hard Disk Drive]
Topology	[Unknown]
Device Sleep	[Disabled]
SATA DEVSLEP Idle Timeout Config	[Disabled]
Serial ATA Port 3	Empty
Software Preserve	Unknown
Port 3	[Enabled]
Hot Plug	[Disabled]
External SATA	[Disabled]
Spin Up Device	[Disabled]
SATA Device Type	[Hard Disk Drive]
Topology	[Unknown]
Device Sleep	[Disabled]
SATA DEVSLEP Idle Timeout Config	[Disabled]
Serial ATA Port 4	Empty
Software Preserve	Unknown
Port 4	[Enabled]
Hot Plug	[Disabled]
External SATA	[Disabled]
Spin Up Device	[Disabled]
SATA Device Type	[Hard Disk Drive]
Topology	[Unknown]
Device Sleep	[Disabled]
SATA DEVSLEP Idle Timeout Config	[Disabled]
Serial ATA Port 5	Empty

Software Preserve	Unknown
Port 5	[Enabled]
Hot Plug	[Disabled]
External SATA	[Disabled]
Spin Up Device	[Disabled]
SATA Device Type	[Hard Disk Drive]
Topology	[Unknown]
Device Sleep	[Disabled]
SATA DEVSLEP Idle Timeout Config	[Disabled]

3.4.9 CSM Configuration

Compatibility Support Module Configuration

CSM Support	[Enabled]
CSM16 Module Version	07.79
GateA20 Active	[Upon Request]
Option ROM Messages	[Force BIOS]
INT19 Trap Response	[Immediate]
Boot option filter	[UEFI and Legacy]
Option ROM execution	
Network	[Do not launch]
Storage	[UEFI]
Video	[Legacy]
Other PCI devices	[UEFI]

3.4.10 USB Configuration

USB Module Version	16
USB Controllers:	1XHCI
USB Devices:	1 Keyboard,1 Mouse

Legacy USB Support	[Enabled]
XHCI Hand-off	[Enabled]
USB Mass Storage Driver Support	[Enabled]
Port 60/64 Emulation	[Disabled]
USB Hardware delays and time-outs:	
USB transfer time-out	[20 sec]
Device reset time-out	[20 sec]
Device power-up delay	[Auto]

3.5 Chipset Settings

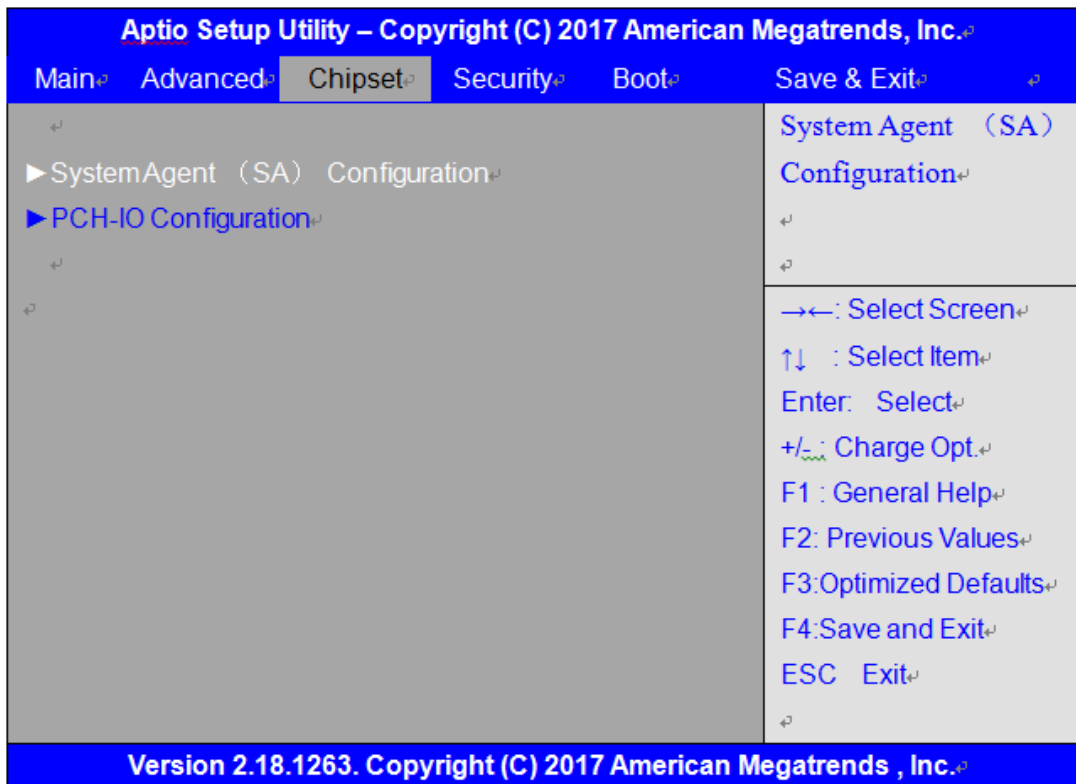

3.5.1 System Agent (SA) Configuration

System Agent Bridge Name	Skylake
SA PCIe Code Version	2.0.0.0
VT-d	Supported
VT-d	[Enabled]
Primary IGFX Boot Display	[VBIOS Deafault]
Secondary IGFX Boot Display	[Disabled]
Active LFP	[eDP Port-A]

Panel Color Depth	[18 Bit]
LCD Backlight Control	[PWM Normal by BIOS]
BIOS Control Backlight Level	[Level 7]
► Graphics Configuration	
IGFX VBIOS Version	1046
Graphics Turbo IMON Current	31
Skip Scanning of External Gfx Card	[Disabled]
Primary Display	[Auto]
Primary PEG	[Auto]
Primary PCIE	[Auto]
Internal Graphics	[Auto]
GTT Size	[8MB]
Aperture Size	[256MB]
DVMT Pre-Allocated	[32M]
DVMT Total Gfx Mem	[256M]
Gfx Low Power Mode	[Enabled]
VDD Enable	[Enabled]
PM Support	[Enabled]
PAVP Enable	[Enabled]
Cdynmax Clamping Enable	[Enabled]
Cd Clock Frequency	[675MHz]
► Intel® Ultrabook Event Support	
IUER Slate Enable	[Disabled]
IUER Dock Enable	[Disabled]
IUER Button Enable	[Disabled]
► DMI/OPI Configuration	
DMI Vc1 Control	[Disabled]
DMI Vcm Control	[Enabled]
► Memory Configuration	
Memory RC Version	2.0.0.1
Memory Frequency	2133MHz
Total Memory	4096MB
VDD	1200
DIMM#0	4096MB
DIMM#1	Not Present
DIMM#2	Not Present

DIMM#3	Not Present
Memory Timings(tCL-tRCD-tRP-tRAS)	5-36
MRC ULT Safe Conifg	[Disabled]
Maximum Memory Frequency	[Auto]
HOB Buffer Size	[Auto]
ECC Support	[Enabled]
Max TOLUD	[Dynamic]
LCD Backlight Mode	[PWM]
Backlight Control	[PWM Normal by BIOS]
BIOS Control Backlight Level	[Level 7]
SA GV	[Enabled]
SA GV Low Freq	[MRC default]
Energy Performance Gain	[Disabled]
EPG DIMM Idd3N	26
EPG DIMM Idd3P	11
Retrain on Fast fall	[Enabled]
Enable RH Prevention	[Enabled]
Row Hammer Solution	[Hardware RHP]
RH Activation Probability	[1/2^11]
Exit On Failure(MRC)	[Enabled]
MC Lock	[Enabled]
Probeless Trace	[Disabled]
Enable/Disable IED(Intel Enhanced Debug)	[Disabled]
Ch Hash Support	[Enabled]
Ch Hash Mask	12488
Ch Hash Interleaved Bit	[BIT8]
VC1 Read Metering	[Enabled]
VC1 RdMeter Time Window	800
VC1 RdMeter Threshold	280
Strong Weak Leaker	7
Memory Scrambler	[Enabled]
Channel A DIMM Control	[Enable both DIMMS]
Channel B DIMM Control	[Enable both DIMMS]
Force Single Rank	[Disabled]
Memory Remap	[Enabled]
Time Measure	[Disabled]
Lpddr Mem WL Set	[Set B]

EV Loader	[Disabled]
EV Loader Delay	[Enabled]
Fast Boot	[Enabled]
DLL Weak Lock Support	[Enabled]
► Memory Thermal Configuration	
► Memory Power and Thermal Throttling	
DDR PowerDown and idle counter	[BIOS]
For LPDDR Only:DDR PowerDown and idle counter	[BIOS]
REFRESH_2X_MODE	[Disabled]
LPDDR Thermal Sensor	[Enabled]
SelfRefresh Enable	[Enabled]
SelfRefresh IdleTimer	512
Throttler CKEMin Defeature	[Enabled]
Throttler CKEMin Timer	48
For LPDDR Only:Throttler CKEMin Defeature	Enabled]
For LPDDR Only:Throttler CKEMin Timer	64
Pwr Down Idle Timer	0
► Dram Power Idle Timer	
Use user provided power weights,scale factor,and channel power floor values	[Disabled]
Energy Scale factor	4
Idle Energy Ch0Dimm0	10
PowerDown Energy Ch0Dimm0	6
Activate Energy Ch0Dimm0	172
Read Energy Ch0Dimm0	212
Write Energy Ch0Dimm0	221
Idle Energy Ch0Dimm1	10
PowerDown Energy Ch0Dimm1	6
Activate Energy Ch0Dimm1	172
Read Energy Ch0Dimm1	212
Write Energy Ch0Dimm1	221
Idle Energy Ch1Dimm0	10

PowerDown Energy Ch1Dimm0	6
Activate Energy Ch1Dimm0	172
Read Energy Ch1Dimm0	212
Write Energy Ch1Dimm0	221
Idle Energy Ch1Dimm0	10
PowerDown Energy Ch1Dimm0	6
Activate Energy Ch1Dimm0	172
Read Energy Ch1Dimm0	212
Write Energy Ch1Dimm0	221
Idle Energy Ch1Dimm1	10
PowerDown Energy Ch1Dimm1	6
Activate Energy Ch1Dimm1	172
Read Energy Ch1Dimm1	212
Write Energy Ch1Dimm1	221

► **Memory Thermal Reporting**

Lock Thermal:Management Registers [Enabled]

Memory Thermal Reporting

Extern Therm Status [Disabled]

Closed Loop Therm Manage [Disabled]

Open Loop Therm Manage [Disabled]

Thermal Threhold Settings

Warm Threshold Ch0 Dimm0 255

Warm Threshold Ch0 Dimm1 255

Hot Threshold Ch0 Dimm0 255

Hot Threshold Ch0 Dimm1 255

Warm Threshold Ch1 Dimm0 255

Warm Threshold Ch1 Dimm1 255

Hot Threshold Ch1 Dimm0 255

Hot Threshold Ch1 Dimm1 255

Thermal Throttle Budget Settings

Warm Budget Ch0 Dimm0	255
Warm Budget Ch0 Dimm1	255
Hot Budget Ch0 Dimm0	255
Hot Budget Ch0 Dimm1	255
Warm Budget Ch1 Dimm0	255
Warm Budget Ch1 Dimm1	255
Hot Budget Ch1 Dimm0	255
Hot Budget Ch1 Dimm1	255

► **Memory RAPL**

Rapl Power Floor Ch0	0
Rapl Power Floor Ch1	0

RAPL PL Lock	[Disabled]
RAPL PL 1 enable	[Disabled]
RAPL PL 1 Power	0
RAPL PL 1 WindowX	0
RAPL PL 1 WindowY	0

RAPL PL 1 enable	[Disabled]
RAPL PL 1 Power	0
RAPL PL 1 WindowX	0
RAPL PL 1 WindowY	0

Memory Thermal Management	[Disabled]
---------------------------	------------

► **Memory Training Algorithms**

Early Command Training	[Disabled]
SenseAmp Offset Training	[Enabled]
Early ReadMPR Timing Centering 2D	[Enabled]
Read MPR Training	[Enabled]
Receive Enable Training	[Enabled]
Jedec Write Leveling	[Enabled]
Early Write Time Centering 2D	[Enabled]
Early Read Time Centering 2D	[Enabled]
Write Timing Centering 1D	[Enabled]
Write Voltage Centering 1D	[Enabled]
Read Timing Centering 1D	[Enabled]
Dimm ODT Training*	[Enabled]

Max RTT_WR	[ODT Off]
DIMM RON Training*	[Enabled]
Write Drive Strength/Equalization 2D*	[Disabled]
Write Slew Rate Training*	[Enabled]
Read ODT Training*	[Enabled]
Read Equalization Training*	[Enabled]
Read Amplifier Training*	[Enabled]
Write Timing Centering 2D	[Enabled]
Read Timing Centering 2D	[Enabled]
Command Voltage Centering	[Enabled]
Write Voltage Centering	[Enabled]
Read Voltage Centering 2D	[Enabled]
Late Command Training	[Enabled]
Round Trip Latency	[Enabled]
Turn Around Timing Training	[Enabled]
Rank Margin Tool	[Disabled]
Memory Test	[Disabled]
DIMM SPD Alias Test	[Enabled]
Receive Enable Centering 1D	[Enabled]
Retrain Margin Check	[Enabled]
Command Power Training	[Disabled]

► **GT-Power Management Control**

GT Info	GT2
RC6(Render Standby)	[Enabled]

3.5.2 PCH-IO Configuration

Intel PCH RC Version	2.0.0.0
Intel PCH SKU Name	PCH-LP Mobile(U) Premium SKU
Intel PCH REV ID	21/C1

► **PCI Express Configuration**

PCI Express Clock Gating	[Enabled]
DMI Link ASPM Control	[Enabled]
Port8xh Decode	[Disabled]

Peer Memory Write Enable	[Disabled]
Compliance Test Mode	[Disabled]
PCIe-USB Glitch W/A	[Disabled]
PCIe function swap	[Enabled]
► PCI Express Gen3 Eq Lanes	
Override SW EQ Settings	[Disabled]
► PCI Express Root Port 1	
PCI Express Root Port 1	[Enabled]
Topology	[Unknown]
ASPM Support	[Auto]
L1 SubStates	[L1.1&L1.2]
Gen3 Eq Phase3 Method	[Software Search]
UPTP	5
DPTP	7
ACS	[Enabled]
URR	[Disabled]
FER	[Disabled]
NFER	[Disabled]
CER	[Disabled]
CTO	[Disabled]
SEFE	[Disabled]
SENF	[Disabled]
SECE	[Disabled]
PME SCI	[Enabled]
Hot Plug	[Disabled]
Advanced Error Reporting	[Enabled]
PCIe Speed	[Auto]
Transmitter Half Swing	[Disabled]
Detect Non-Compliance Device	[Disabled]
Extra Bus Reserved	0
Reserved Memory	10
Prefetchable Memory	10
Reserved I/O	4
PCIE Cp	2
PCIE Cm	6
PCIE LTR	[Enabled]
PCIE LTR Lock	[Disabled]

PCH PCIe CLKREQ# Configuration	
PCIE1 CLKREQ Mapping Override	[Default]
Snoop Latency Ocerride	[Auto]
Non Snoop Latency Ocerride	[Auto]

► **PCI Express Root Port 2**

PCI Express Root Port 2	[Enabled]
Topology	[Unknown]
ASPM Support	[Auto]
L1 SubStates	[L1.1&L1.2]
Gen3 Eq Phase3 Method	[Software Search]
UPTP	5
DPTP	7
ACS	[Enabled]
URR	[Disabled]
FER	[Disabled]
NFER	[Disabled]
CER	[Disabled]
CTO	[Disabled]
SEFE	[Disabled]
SENF	[Disabled]
SECE	[Disabled]
PME SCI	[Enabled]
Hot Plug	[Disabled]
Advanced Error Reporting	[Enabled]
PCIe Speed	[Auto]
Transmitter Half Swing	[Disabled]
Detect Non-Compliance Device	[Disabled]
Extra Bus Reserved	0
Reserved Memory	10
Prefetchable Memory	10
Reserved I/O	4
PCIE Cp	2
PCIE Cm	6
PCIE LTR	[Enabled]
PCIE LTR Lock	[Disabled]

PCH PCIe CLKREQ# Configuration

PCIE2 CLKREQ Mapping Override	[Default]
Snoop Latency Ocerride	[Auto]
Non Snoop Latency Ocerride	[Auto]
► PCI Express Root Port 3	
PCI Express Root Port 3	[Enabled]
Topology	[Unknown]
ASPM Support	[Auto]
L1 SubStates	[L1.1&L1.2]
Gen3 Eq Phase3 Method	[Software Search]
UPTP	5
DPTP	7
ACS	[Enabled]
URR	[Disabled]
FER	[Disabled]
NFER	[Disabled]
CER	[Disabled]
CTO	[Disabled]
SEFE	[Disabled]
SENF	[Disabled]
SECE	[Disabled]
PME SCI	[Enabled]
Hot Plug	[Disabled]
Advanced Error Reporting	[Enabled]
PCIe Speed	[Auto]
Transmitter Half Swing	[Disabled]
Detect Non-Compliance Device	[Disabled]
Extra Bus Reserved	0
Reserved Memory	10
Prefetchable Memory	10
Reserved I/O	4
PCIE Cp	2
PCIE Cm	6
PCIE LTR	[Enabled]
PCIE LTR Lock	[Disabled]
PCH PCIe CLKREQ# Configuration	
PCIE3 CLKREQ Mapping Override	[Default]
Snoop Latency Ocerride	[Auto]

Non Snoop Latency Ocerride	[Auto]
► PCI Express Root Port 4	
PCI Express Root Port 4	[Enabled]
Topology	[Unknown]
ASPM Support	[Auto]
L1 SubStates	[L1.1&L1.2]
Gen3 Eq Phase3 Method	[Software Search]
UPTP	5
DPTP	7
ACS	[Enabled]
URR	[Disabled]
FER	[Disabled]
NFER	[Disabled]
CER	[Disabled]
CTO	[Disabled]
SEFE	[Disabled]
SENF	[Disabled]
SECE	[Disabled]
PME SCI	[Enabled]
Hot Plug	[Disabled]
Advanced Error Reporting	[Enabled]
PCIe Speed	[Auto]
Transmitter Half Swing	[Disabled]
Detect Non-Compliance Device	[Disabled]
Extra Bus Reserved	0
Reserved Memory	10
Prefetchable Memory	10
Reserved I/O	4
PCIE Cp	2
PCIE Cm	6
PCIE LTR	[Enabled]
PCIE LTR Lock	[Disabled]
PCH PCIe CLKREQ# Configuration	
PCIE4 CLKREQ Mapping Override	[Default]
Snoop Latency Ocerride	[Auto]
Non Snoop Latency Ocerride	[Auto]

► **PCI Express Root Port 5**

PCI Express Root Port 5	[Enabled]
Topology	[Unknown]
ASPM Support	[Auto]
L1 SubStates	[L1.1&L1.2]
Gen3 Eq Phase3 Method	[Software Search]
UPTP	5
DPTP	7
ACS	[Enabled]
URR	[Disabled]
FER	[Disabled]
NFER	[Disabled]
CER	[Disabled]
CTO	[Disabled]
SEFE	[Disabled]
SENF	[Disabled]
SECE	[Disabled]
PME SCI	[Enabled]
Hot Plug	[Disabled]
Advanced Error Reporting	[Enabled]
PCIe Speed	[Auto]
Transmitter Half Swing	[Disabled]
Detect Non-Compliance Device	[Disabled]
Extra Bus Reserved	0
Reserved Memory	10
Prefetchable Memory	10
Reserved I/O	4
PCIE Cp	2
PCIE Cm	6
PCIE LTR	[Enabled]
PCIE LTR Lock	[Disabled]
PCH PCIe CLKREQ# Configuration	
PCIE5 CLKREQ Mapping Override	[Default]
Snoop Latency Ocerride	[Auto]
Non Snoop Latency Ocerride	[Auto]

► **PCI Express Root Port 6**

PCI Express Root Port 6	[Enabled]
-------------------------	-----------

Topology	[Unknown]
ASPM Support	[Auto]
L1 SubStates	[L1.1&L1.2]
Gen3 Eq Phase3 Method	[Software Search]
UPTP	5
DPTP	7
ACS	[Enabled]
URR	[Disabled]
FER	[Disabled]
NFER	[Disabled]
CER	[Disabled]
CTO	[Disabled]
SEFE	[Disabled]
SENF	[Disabled]
SECE	[Disabled]
PME SCI	[Enabled]
Hot Plug	[Disabled]
Advanced Error Reporting	[Enabled]
PCIe Speed	[Auto]
Transmitter Half Swing	[Disabled]
Detect Non-Compliance Device	[Disabled]
Extra Bus Reserved	0
Reserved Memory	10
Prefetchable Memory	10
Reserved I/O	4
PCIE Cp	2
PCIE Cm	6
PCIE LTR	[Enabled]
PCIE LTR Lock	[Disabled]
PCH PCIe CLKREQ# Configuration	
PCIE6 CLKREQ Mapping Override	[Default]
Snoop Latency Ocerride	[Auto]
Non Snoop Latency Ocerride	[Auto]
► PCI Express Root Port 7	
PCI Express Root Port 7	[Enabled]
Topology	[Unknown]

ASPM Support	[Auto]
L1 SubStates	[L1.1&L1.2]
Gen3 Eq Phase3 Method	[Software Search]
UPTP	5
DPTP	7
ACS	[Enabled]
URR	[Disabled]
FER	[Disabled]
NFER	[Disabled]
CER	[Disabled]
CTO	[Disabled]
SEFE	[Disabled]
SENF	[Disabled]
SECE	[Disabled]
PME SCI	[Enabled]
Hot Plug	[Disabled]
Advanced Error Reporting	[Enabled]
PCIe Speed	[Auto]
Transmitter Half Swing	[Disabled]
Detect Non-Compliance Device	[Disabled]
Extra Bus Reserved	0
Reserved Memory	10
Prefetchable Memory	10
Reserved I/O	4
PCIE Cp	2
PCIE Cm	6
PCIE LTR	[Enabled]
PCIE LTR Lock	[Disabled]
PCH PCIe CLKREQ# Configuration	
PCIE7 CLKREQ Mapping Override	[Default]
Snoop Latency Ocerride	[Auto]
Non Snoop Latency Ocerride	[Auto]

► **PCI Express Root Port 8**

PCI Express Root Port 8	[Enabled]
Topology	[Unknown]
ASPM Support	[Auto]

L1 SubStates	[L1.1&L1.2]
Gen3 Eq Phase3 Method	[Software Search]
UPTP	5
DPTP	7
ACS	[Enabled]
URR	[Disabled]
FER	[Disabled]
NFER	[Disabled]
CER	[Disabled]
CTO	[Disabled]
SEFE	[Disabled]
SENF	[Disabled]
SECE	[Disabled]
PME SCI	[Enabled]
Hot Plug	[Disabled]
Advanced Error Reporting	[Enabled]
PCIe Speed	[Auto]
Transmitter Half Swing	[Disabled]
Detect Non-Compliance Device	[Disabled]
Extra Bus Reserved	0
Reserved Memory	10
Prefetchable Memory	10
Reserved I/O	4
PCIE Cp	2
PCIE Cm	6
PCIE LTR	[Enabled]
PCIE LTR Lock	[Disabled]
PCH PCIe CLKREQ# Configuration	
PCIE8 CLKREQ Mapping Override	[Default]
Snoop Latency Ocerride	[Auto]
Non Snoop Latency Ocerride	[Auto]

► **PCI Express Root Port 9**

PCI Express Root Port 9	[Enabled]
Topology	[Unknown]
ASPM Support	[Auto]
L1 SubStates	[L1.1&L1.2]

Gen3 Eq Phase3 Method	[Software Search]
UPTP	5
DPTP	7
ACS	[Enabled]
URR	[Disabled]
FER	[Disabled]
NFER	[Disabled]
CER	[Disabled]
CTO	[Disabled]
SEFE	[Disabled]
SENF	[Disabled]
SECE	[Disabled]
PME SCI	[Enabled]
Hot Plug	[Disabled]
Advanced Error Reporting	[Enabled]
PCIe Speed	[Auto]
Transmitter Half Swing	[Disabled]
Detect Non-Compliance Device	[Disabled]
Extra Bus Reserved	0
Reserved Memory	10
Prefetchable Memory	10
Reserved I/O	4
PCIE Cp	2
PCIE Cm	6
PCIE LTR	[Enabled]
PCIE LTR Lock	[Disabled]
PCH PCIe CLKREQ# Configuration	
PCIE9 CLKREQ Mapping Override	[Default]
Snoop Latency Ocerride	[Auto]
Non Snoop Latency Ocerride	[Auto]
► PCI Express Root Port 10	
PCI Express Root Port 10	[Enabled]
Topology	[Unknown]
ASPM Support	[Auto]
L1 SubStates	[L1.1&L1.2]
Gen3 Eq Phase3 Method	[Software Search]
UPTP	5

DPTP	7
ACS	[Enabled]
URR	[Disabled]
FER	[Disabled]
NFER	[Disabled]
CER	[Disabled]
CTO	[Disabled]
SEFE	[Disabled]
SENF	[Disabled]
SECE	[Disabled]
PME SCI	[Enabled]
Hot Plug	[Disabled]
Advanced Error Reporting	[Enabled]
PCIe Speed	[Auto]
Transmitter Half Swing	[Disabled]
Detect Non-Compliance Device	[Disabled]
Extra Bus Reserved	0
Reserved Memory	10
Prefetchable Memory	10
Reserved I/O	4
PCIE Cp	2
PCIE Cm	6
PCIE LTR	[Enabled]
PCIE LTR Lock	[Disabled]
PCH PCIe CLKREQ# Configuration	
PCIE10 CLKREQ Mapping Override	[Default]
Snoop Latency Ocerride	[Auto]
Non Snoop Latency Ocerride	[Auto]

► **PCI Express Root Port 11**

PCI Express Root Port 11	[Enabled]
Topology	[Unknown]
ASPM Support	[Auto]
L1 SubStates	[L1.1&L1.2]
Gen3 Eq Phase3 Method	[Software Search]
UPTP	5
DPTP	7

ACS	[Enabled]
URR	[Disabled]
FER	[Disabled]
NFER	[Disabled]
CER	[Disabled]
CTO	[Disabled]
SEFE	[Disabled]
SENF	[Disabled]
SECE	[Disabled]
PME SCI	[Enabled]
Hot Plug	[Disabled]
Advanced Error Reporting	[Enabled]
PCIe Speed	[Auto]
Transmitter Half Swing	[Disabled]
Detect Non-Compliance Device	[Disabled]
Extra Bus Reserved	0
Reserved Memory	10
Prefetchable Memory	10
Reserved I/O	4
PCIE Cp	2
PCIE Cm	6
PCIE LTR	[Enabled]
PCIE LTR Lock	[Disabled]
PCH PCIe CLKREQ# Configuration	
PCIE11 CLKREQ Mapping Override	[Default]
Snoop Latency Ocerride	[Auto]
Non Snoop Latency Ocerride	[Auto]

► **PCI Express Root Port 12**

PCI Express Root Port 12	[Enabled]
Topology	[Unknown]
ASPM Support	[Auto]
L1 SubStates	[L1.1&L1.2]
Gen3 Eq Phase3 Method	[Software Search]
UPTP	5
DPTP	7
ACS	[Enabled]

URR	[Disabled]
FER	[Disabled]
NFER	[Disabled]
CER	[Disabled]
CTO	[Disabled]
SEFE	[Disabled]
SENF	[Disabled]
SECE	[Disabled]
PME SCI	[Enabled]
Hot Plug	[Disabled]
Advanced Error Reporting	[Enabled]
PCIe Speed	[Auto]
Transmitter Half Swing	[Disabled]
Detect Non-Compliance Device	[Disabled]
Extra Bus Reserved	0
Reserved Memory	10
Prefetchable Memory	10
Reserved I/O	4
PCIE Cp	2
PCIE Cm	6
PCIE LTR	[Enabled]
PCIE LTR Lock	[Disabled]
PCH PCIe CLKREQ# Configuration	
PCIE12 CLKREQ Mapping Override	[Default]
Snoop Latency Ocerride	[Auto]
Non Snoop Latency Ocerride	[Auto]
▶ USB Configuration	
USB Precondition	[Disabled]
XHCI Disable Compliance Mode	[FALSE]
xDCI Support	[Disabled]
USB Port Disable Override	[Disabled]
▶ BIOS Security Configuration	
RTC Lock	[Enabled]
BIOS Lock	[Disabled]
▶ HD Audio Configuration	
HD Audio	[Autio]

Audio DSP	[Disabled]
HDA-Link Codec Select	[Platform Onboard]
iDisplay Audio Disconnect	[Disabled]
PME Enable	[Disabled]

► **HD Audio Advanced Configuration**

HD Audio Subsystem Advanced Configuration Settings

I/O Buffer Control:

I/O Buffer Ownership [HD-Audio Link]

I/O Buffer Voltage Select [3.3V]

Statically Switchable BCLK Clock

Frequency Configuration:

HD Audio Link Frequency [24MHz]

iDisplay Link Frequency [96MHz]

► **HD Audio DSP Features Configuration**

HD Audio Subsystem Features Configuration(ACPI)

Audio DSP NHLT Endpoints:

Configuration:

DMIC [4 Mic Array]

Bluetooth [Disabled]

I2S [Disabled]

Audio DSP Feature Support:

WoV(Wake on Voice) [Disabled]

Bluetooth Sideband [Disabled]

BT Intel HFP [Disabled]

BT Intel A2DP [Disabled]

Codec based VAD [Disabled]

DSP based Speech.Pre-Processing Disabled [Disabled]

Voice Activity Detection [Intel Wake on Voice]

Audio DSP Pre/Post-Processing

Module Support:

Waves [Disabled]

DTS [Disabled]

IntelSst Speech [Disabled]

Dolby	[Disabled]
ForteMedia SAMSoft	[Disabled]
Intel WoV	[Disabled]
Sound Research IP	[Disabled]
Conexant Pre-Process	[Disabled]
Conexant Smart Amp	[Disabled]
Custom Module 'Alpha'	[Disabled]
Custom Module 'Beta'	[Disabled]
Custom Module 'Gamma'	[Disabled]

► **Serial IO Configuration**

Touch Panel	[SPI Touch]
BT/UART Mux Select	[UART Signal]

I2C0 Controller	[Disabled]
I2C1 Controller	[Disabled]
I2C2 Controller	[Disabled]
I2C3 Controller	[Disabled]
I2C4 Controller	[Disabled]
I2C5 Controller	[Disabled]
SPI0 Controller	[Disabled]
SPI1 Controller	[Disabled]
UART0 Controller	[Disabled]
UART1 Controller	[Disabled]
UART2 Controller	[Disabled]
GPIO Controller	[Enabled]

► **Serial IO GPIO Settings**

GPIO IRQ Route	[IRQ14]
----------------	---------

WITT/MITT Test Device	[Disabled]
UART Test Device	[Disabled]
Additional Serial IO devices	[Disabled]

► **SerialIO timing parameters**

SerialIO timing parameters	[Disabled]
----------------------------	------------

► **SkyCam Configuration**

SkyCam CIO2 Device	[Disabled]
Control Logic 0	[Disabled]

Control Logic 1	[Disabled]
Control Logic 2	[Disabled]
Control Logic 3	[Disabled]
Link0	[Disabled]
Link1	[Disabled]
Link2	[Disabled]
Link3	[Disabled]
PORT-A HS-RXEN/TEM-EN Override	[Disabled]
PORT-B HS-RXEN/TEM-EN Override	[Disabled]
PORT-C HS-RXEN/TEM-EN Override	[Disabled]
PORT-D HS-RXEN/TEM-EN Override	[Disabled]
PORT-A CTLE	[Enabled]
PORT-B CTLE	[Enabled]
PORT-C/D CTLE	[Enabled]
PORT-A CTLE CAP Value	e
PORT-A CTLE RES Value	d
PORT-B CTLE CAP Value	e
PORT-B CTLE RES Value	d
PORT-C/D CTLE CAP Value	e
PORT-C/D CTLE RES Value	d
PORT-A TRIM	[Enabled]
PORT-B TRIM	[Enabled]
PORT-C TRIM	[Enabled]
PORT-D TRIM	[Enabled]
PORT-A Data Trim Value	bbbb
PORT-B Data Trim Value	bbbb
PORT-C/D Data Trim Value	cccc
PORT-A Clk Trim Value	a
PORT-B Clk Trim Value	a
PORT-C Clk Trim Value	9
PORT-D Clk Trim Value	a

► **SCS Configuration**

eMMC 5.0 Controller	[Enabled]
eMMC 5.0 HS400 Mode	[Enabled]
Driver Strength	[33 Ohm]
SDCard 3.0 Controller	[Disabled]

► ISH Configuration	
ISH Controller	[Disabled]
PDT Unlock Message	[Disabled]
► TraceHub Configuration Menu	
TraceHub Enabled Mode	[Disabled]
MemRegion 0 Buffer Size	[1MB]
MemRegion 1 Buffer Size	[1MB]
► Pch Thermal Throttling Control	
Thermal Throttling Level	[Suggested Setting]
DMI Thermal Setting	[Suggested Setting]
SATA Thermal Setting	[Suggested Setting]
► SB Porting Configuration	
SATA RAID ROM	[Legacy ROM]
DCI enable(HDCIEN)	[Disabled]
DCI Auto Detect Enabled	[Enabled]
Debug Port Selection	[Legacy UART]
GNSS	[Disabled]
PCH LAN Controller	[Enabled]
LAN PHY Drives LAN_WAKE#	[Disabled]
Sensor Hub Type	[None]
DeepSx Power Policies	[Disabled]
LAN Wake From DeepSx	[Enabled]
Wake on LAN	[Enabled]
SLP_LAN# Low on DC Power	[Enabled]
K1 off	[Enabled]
Wake on WLAN Enable	[Disabled]
Disable DSX ACPRESENT PullDown	[Disabled]
CLKRUN# Logic	[Enabled]
Serial IRQ Mode	[Continuous]
Port 61h Bit-4 Emulation	[Enabled]
High Precision Timer	[Enabled]
State After G3	[S5 State]
Port 80h Redirection	[LPC Bus]
Enhance Port 80h LPC Decoding	[Enabled]

Compatible Revision ID	[Disabled]
PCH Cross Throttling	[Enabled]
Disable Energy Reporting	[Disabled]
Capsule Reset Type	[Capsule S3 Resume]
Pcie Pll SSC	[Auto]
IOAPIC 24-119 Entries	[Enabled]
Unlock PCH P2SB	[Disabled]
PMC READ DISABLE	[Enabled]

3.6 Security Settings

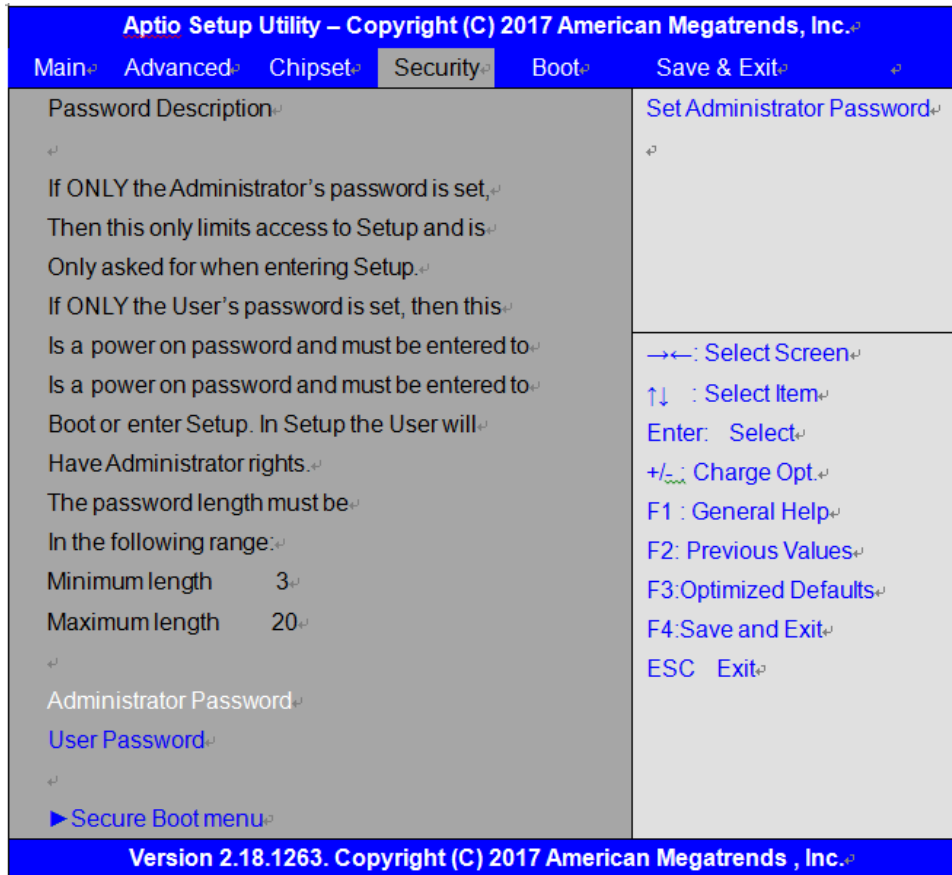

3.6.1 Administrator Password



3.6.2 User Password



Type the password with up to 20 characters and then press <Enter> key. This will clear all previously typed CMOS passwords. You will be requested to confirm the password. Type the password again and press <Enter> key. You may press <Esc> key to abandon password entry operation.

To clear the password, just press <Enter> key when password input window pops up. A confirmation message will be shown on the screen as to whether the password will be disabled. You will have direct access to BIOS setup without typing any password after system reboot once the password is disabled.

Once the password feature is used, you will be requested to type the password each time you

enter BIOS setup. This will prevent unauthorized persons from changing your system configurations.

Also, the feature is capable of requesting users to enter the password prior to system boot to control unauthorized access to your computer. Users may enable the feature in Security Option of Advanced BIOS Features. If Security Option is set to System, you will be requested to enter the password before system boot and when entering BIOS setup; if Security Option is set to Setup, you will be requested for password for entering BIOS setup.

3.7 Boot Settings

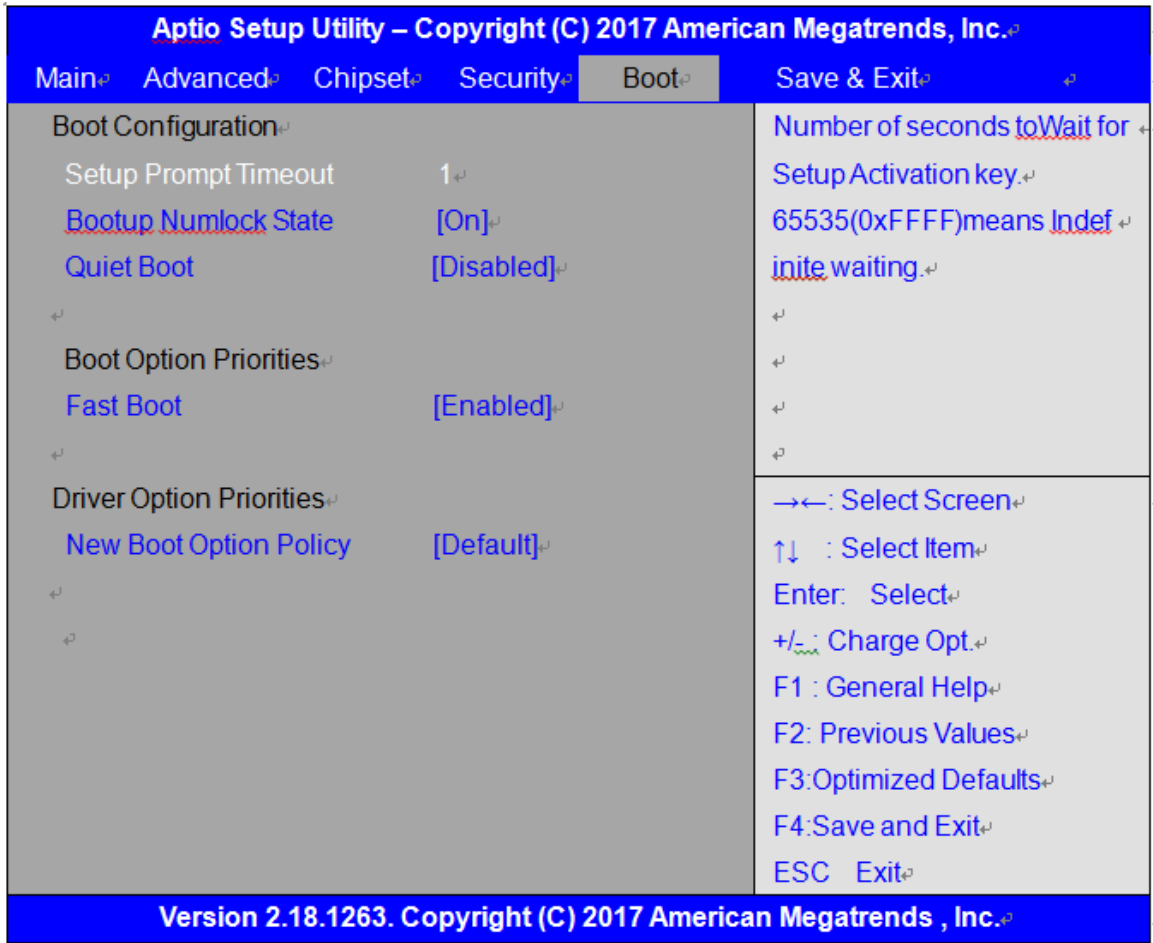

Setup Prompt Timeout	1
Bootup Numlock State	[On]
Quiet Boot	[Disabled]
Boot Option Priorities	
Fast Boot	[Disabled]
Driver Option Priorities	
New Boot Option Policy	[Default]

3.8 Save & Exit Settings

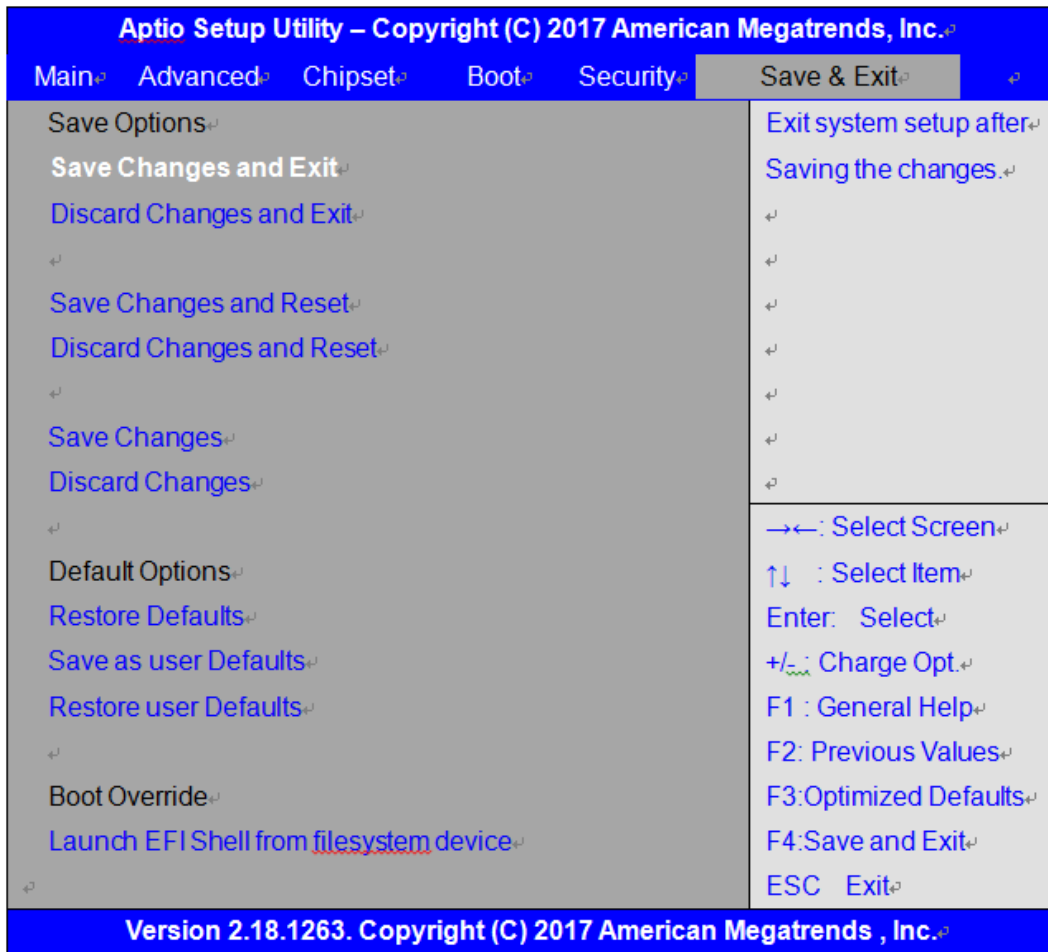

Save Changes and Exit

Save & Exit Setup save Configuration and exit ?

[Yes]

[No]

Discard Changes and Ext

Exit Without Saving Quit without saving?

[Yes]

[No]

Save Changes and Reset

Reset the system after Saving The changes?

[Yes]

[No]

Discard Changes and Reset

Reset system setup without Saving any changes?

[Yes]

[No]

Save Changes

Save Setup done so far to any of the setup options?

[Yes]

[No]

Discard Changes

Discard Changes done so far to any of the setup options?

[Yes]

[No]

Restore Defaults

Restore /Load Defaults values for all the setup options?

[Yes]

[No]

Save as user Defaults

Save the changes done so far as User Defaults?

[Yes]

[No]

Restore user Defaults

Restore the User Defaults to all the setup options?

[Yes]

[No]

Boot Override

Launch EFI Shell from filesystem device

WARNING Not Found

[ok]

Chapter 4 Installation of Drivers

This chapter describes the installation procedures for software and drivers under the windows 8.1 & 10. The software and drivers are included with the motherboard. The contents include **Intel H170 , Graphics 530 chipset driver, Audio driver, Intel® management engine interface, and DPTF Driver Installation instructions are given below.**

Important Note:

After installing your Windows operating system, you must install first the Intel Chipset Software Installation Utility before proceeding with the installation of drivers.



4.1 Intel H170 Chipset

To install the Intel H170 chipset driver, please follow the steps below.

Step 1. Select **Intel H170 Chipset** from the list



Step 2. Here is welcome page. Please make sure you save and exit all programs before install. Click **Next**.

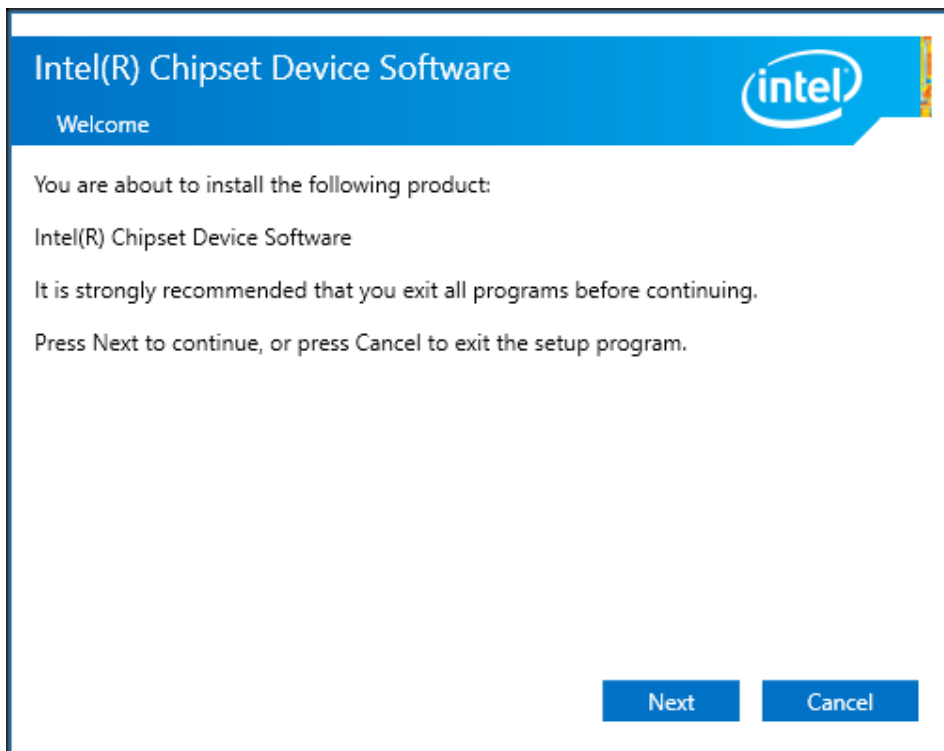

Step3. Read the license agreement. Click **Accept** to accept all of the terms of the license agreement.

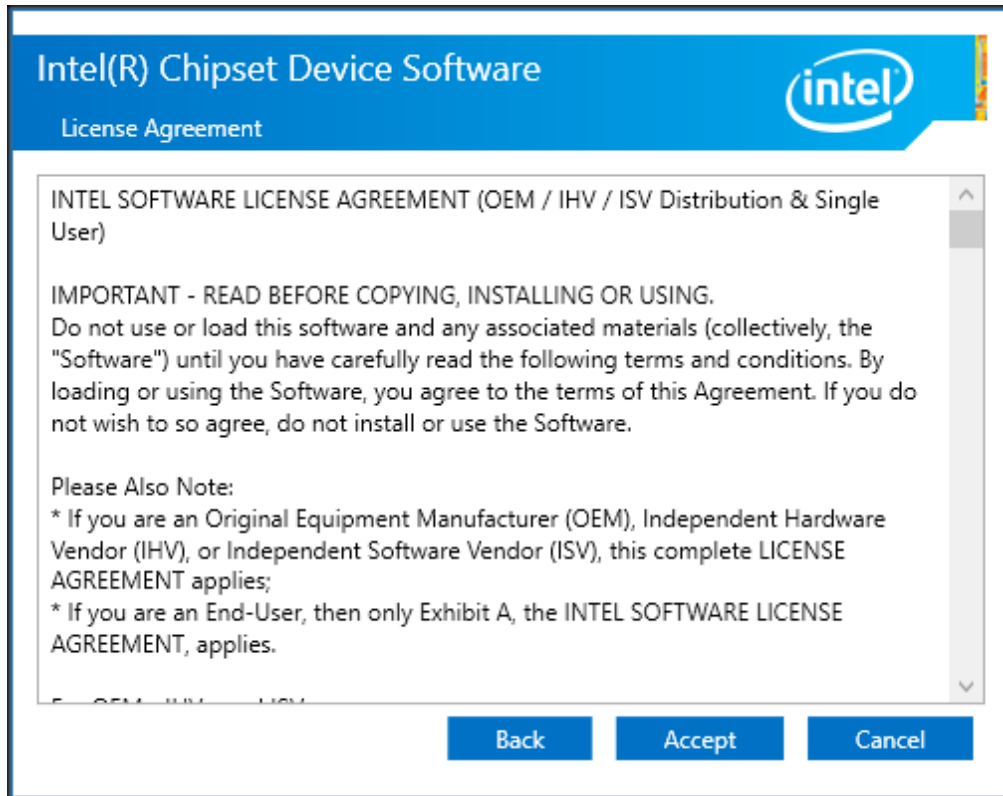

Step4. Click **Install** to begin the installation.

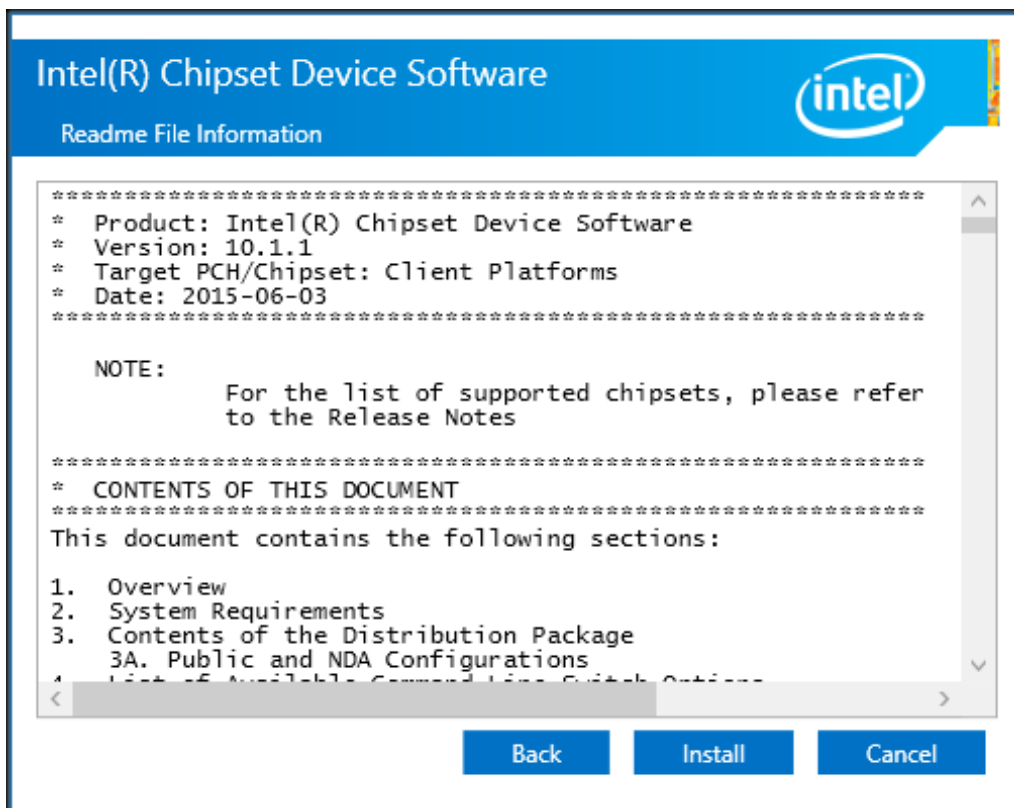

Step5. Select **Restart Now** to reboot your computer for the changes to take effect.

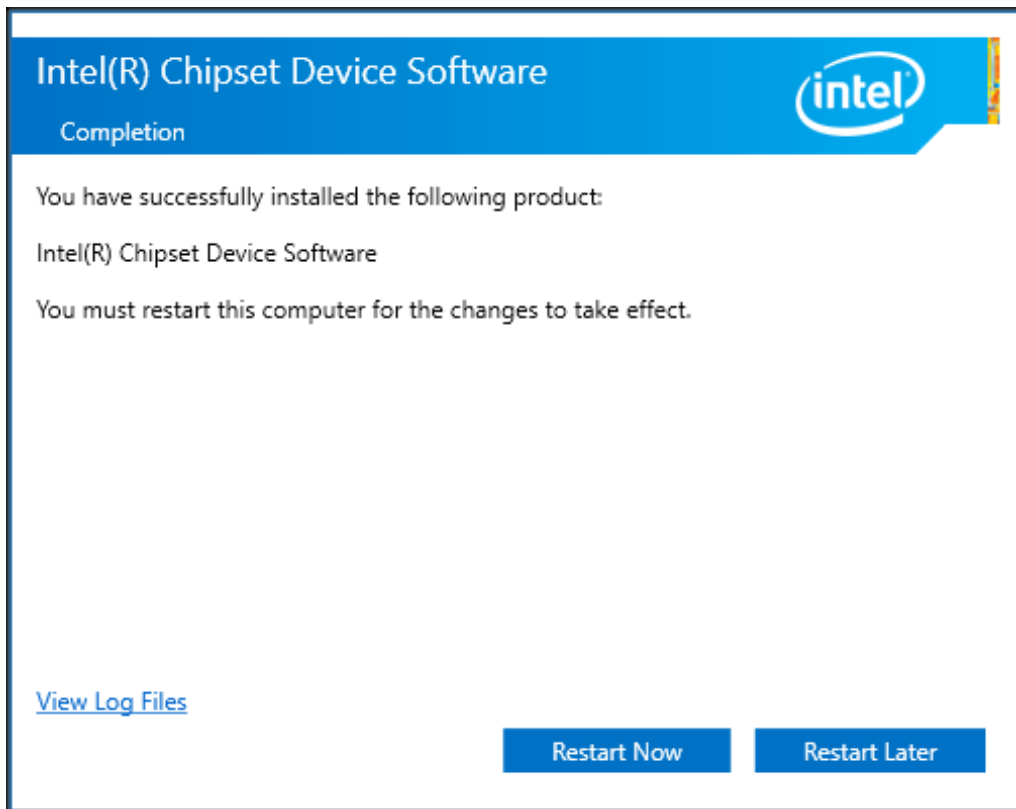

4.2 Intel® HD Graphics 530 Chipset

To install the Intel® HD Graphics 530 Chipset, please follow the steps below.

Step 1. Select Intel® HD Graphics 530 Chipset from the list.



Step2. Click Next.

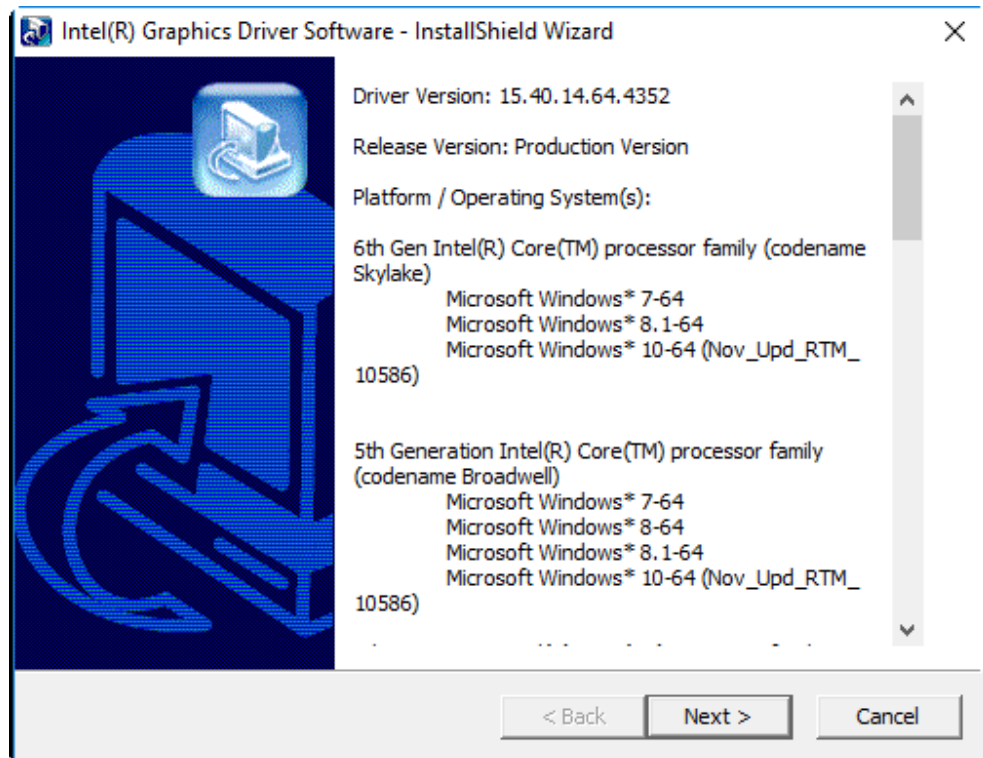

Step3. Choose **automatically run** function and Click **Next** to setup program.

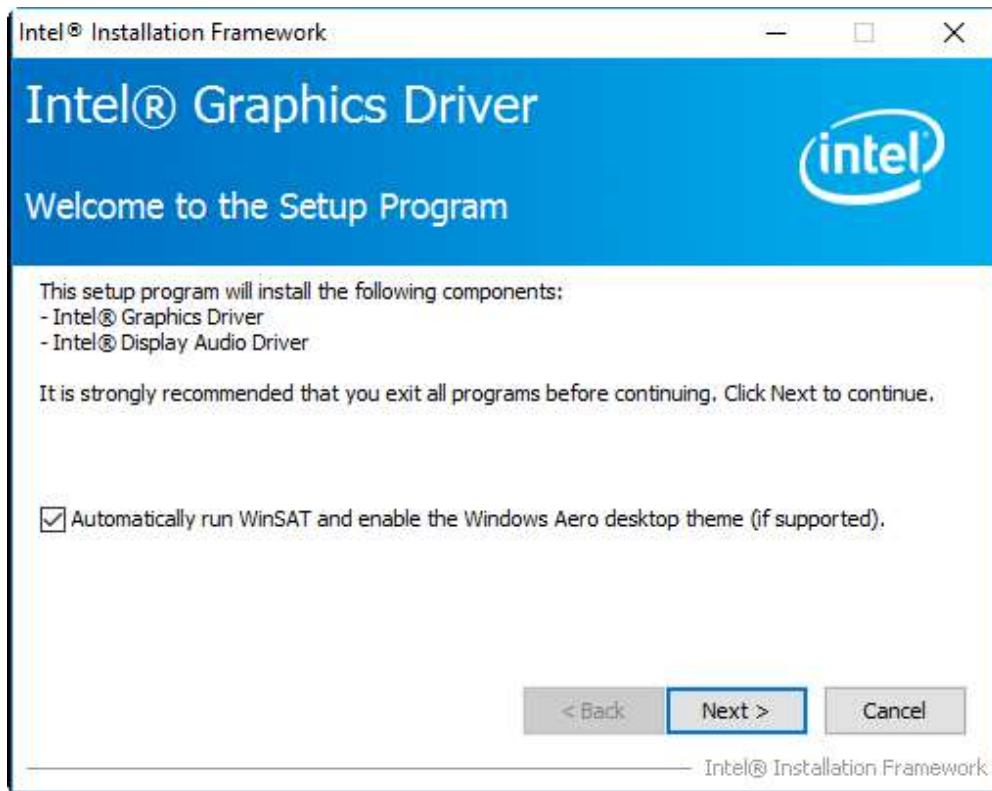

Step4. Read the license agreement. Click **Yes** to accept all of the terms of the license agreement.

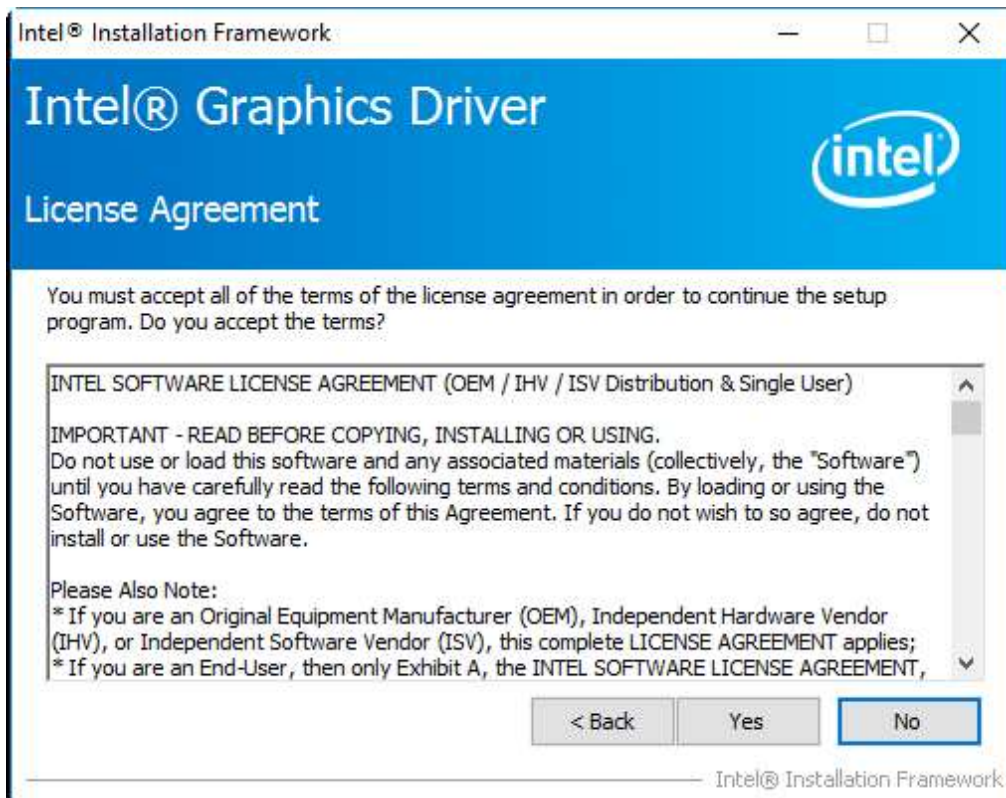

Step5. Click **Next** to continue.

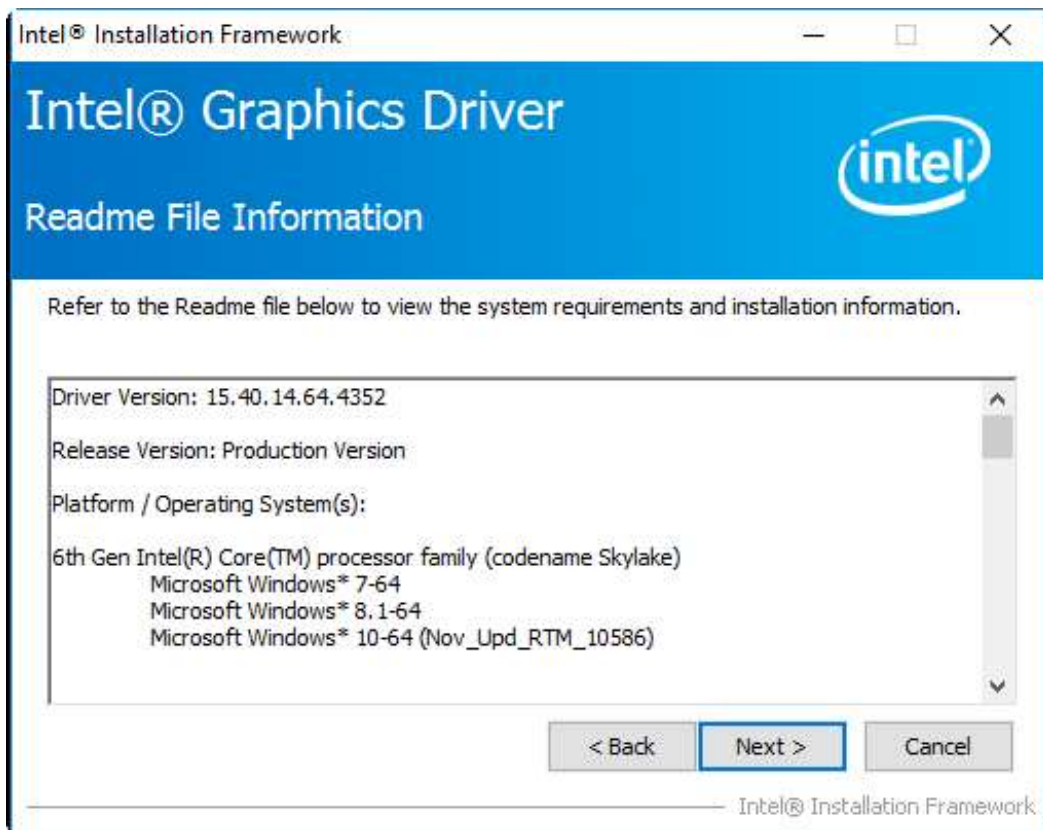

Step6. Here is Intel product improvement program information, you can choose **Accept** or **Decline** by your option and installation will go to next step.

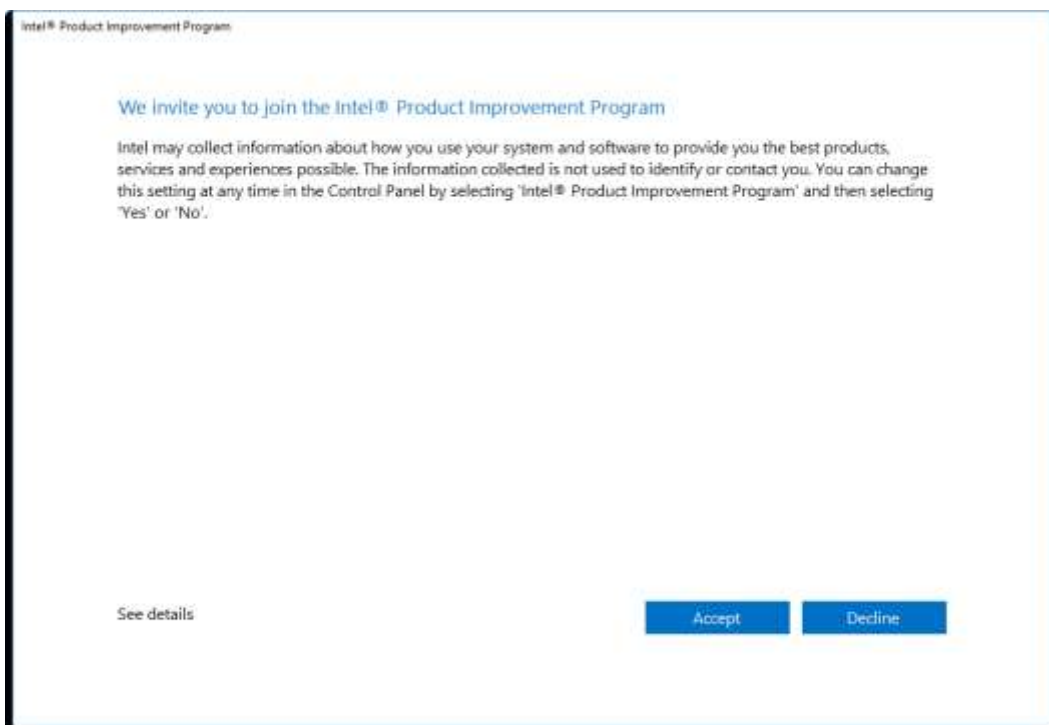

Step7. Click **Next** to continue the program.

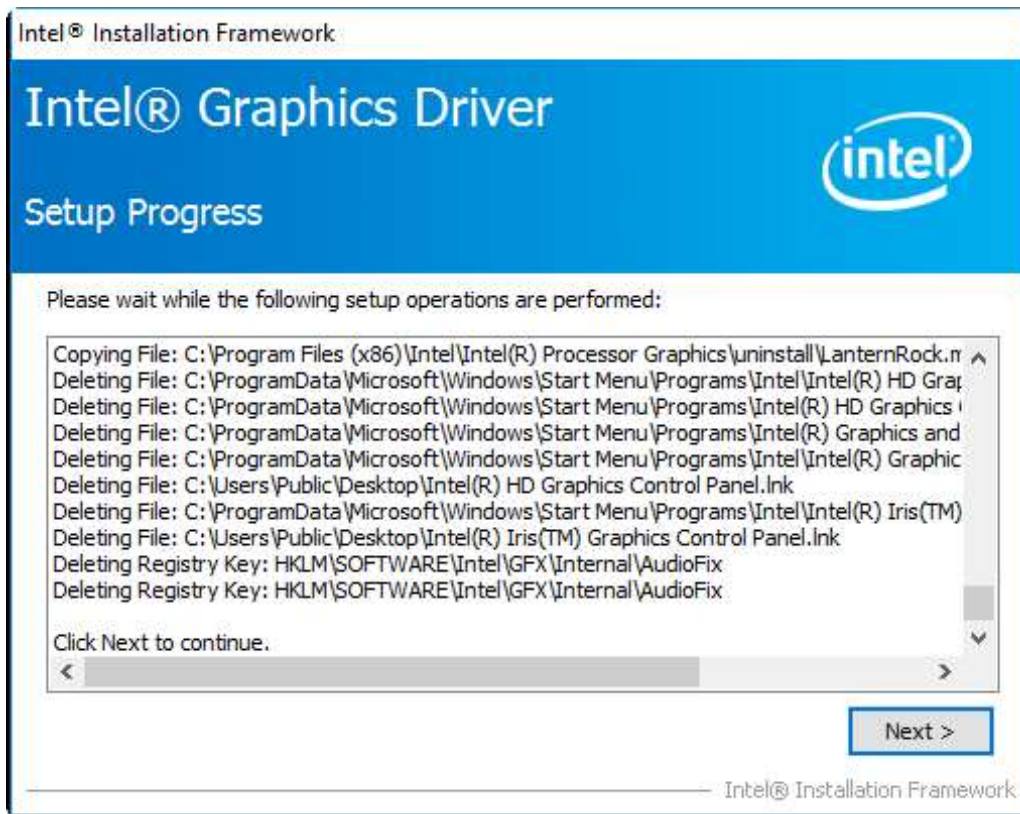

Step8. Select **Yes, I want to restart this computer now.** Click **Finish** to complete installation.

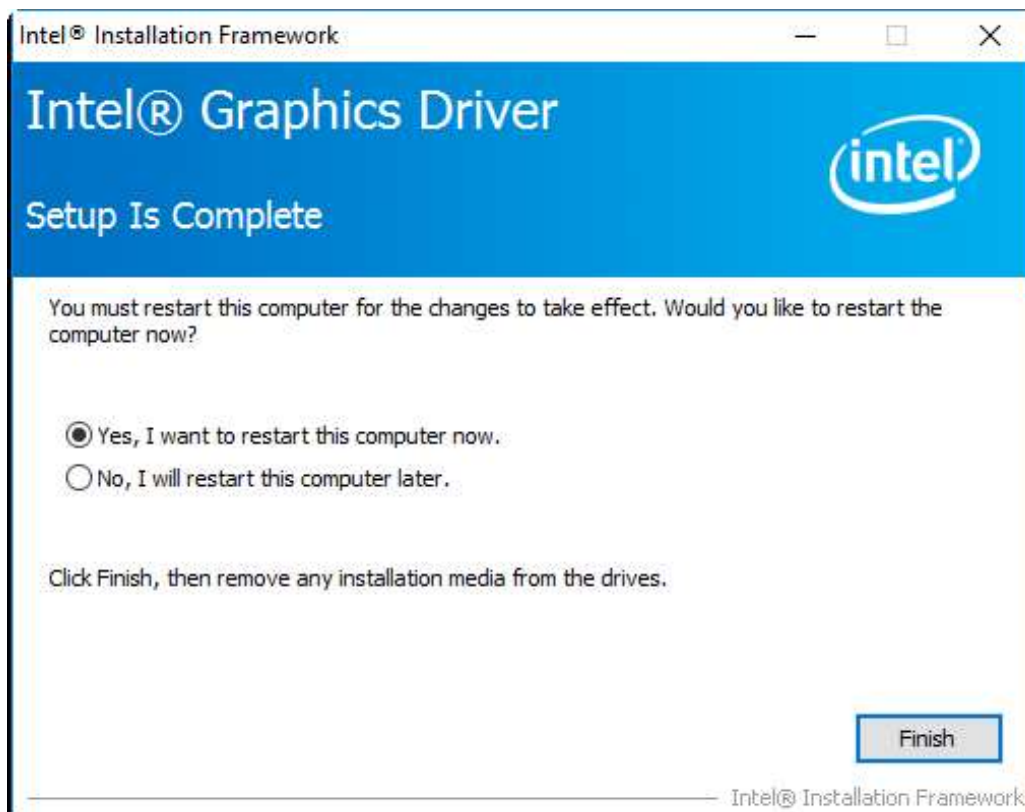

4.3 Realtek ALC662 HD Audio Driver Installation

To install the Realtek ALC662 HD Audio Driver, please follow the steps below.

Step1. Select **Realtek AL662 HD Audio Driver** from the list



Step2. Click **Next** to continue.

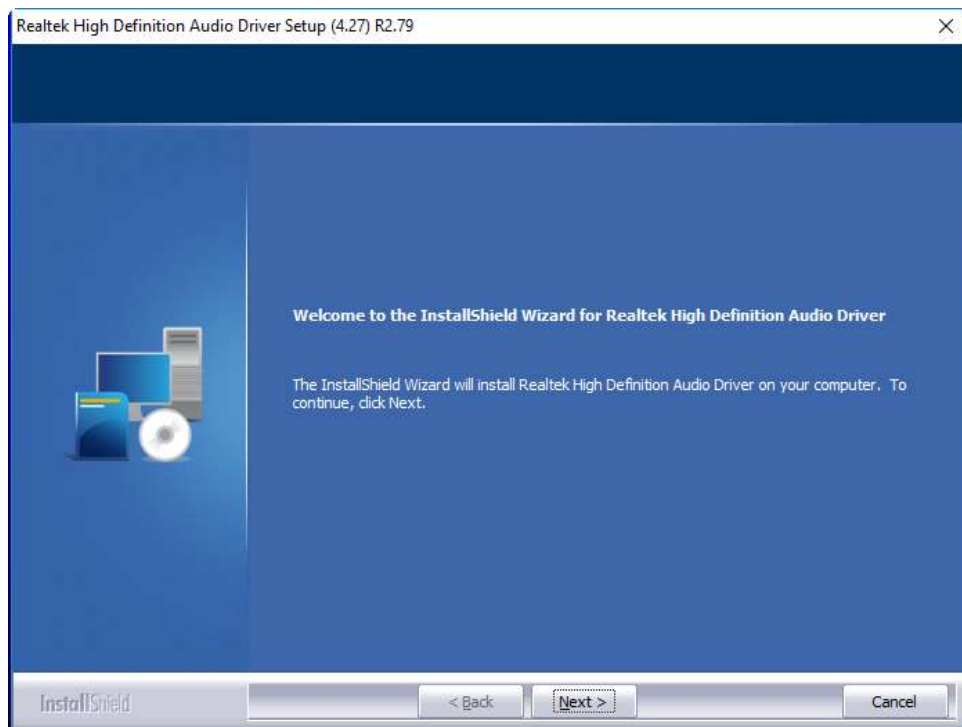

Step3. Click **Yes, I want to restart my computer now.** Click **Finish** to complete the installation.

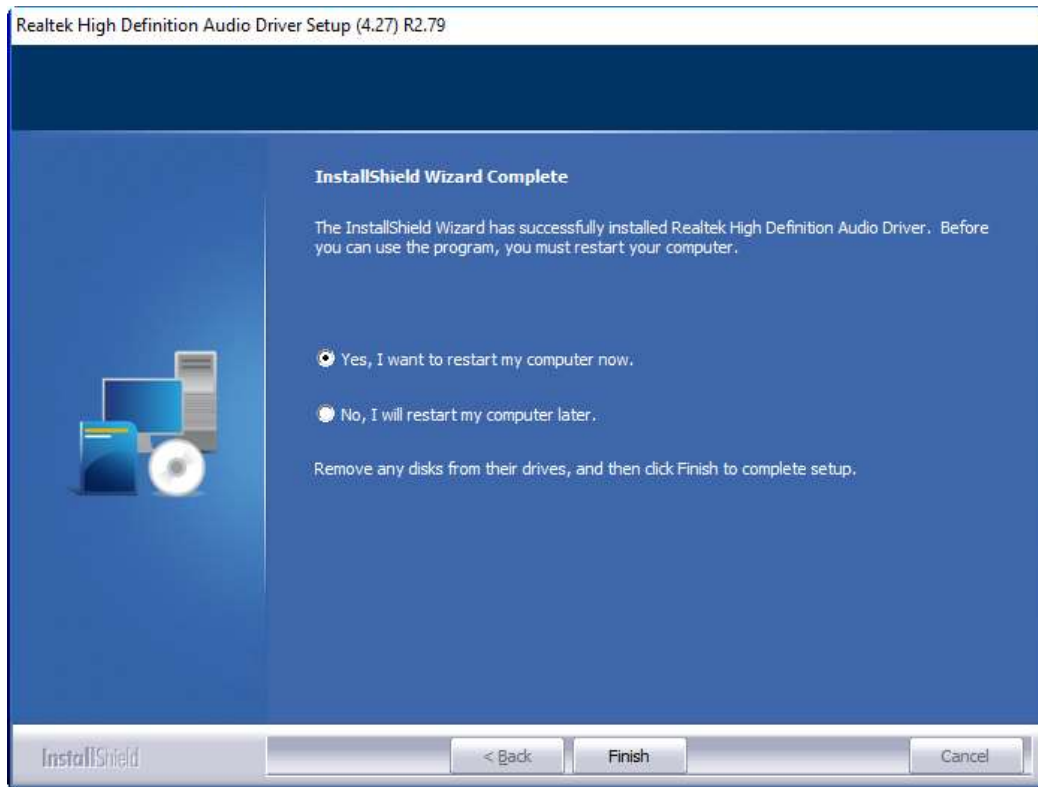

4.4 Intel® Management Engine Interface

To install the Intel® Management Engine Interface, please follow the steps below.

Step1. Select Intel® Management Engine Interface from the list



Step2. Select setup language you need. Click **Next** to continue.

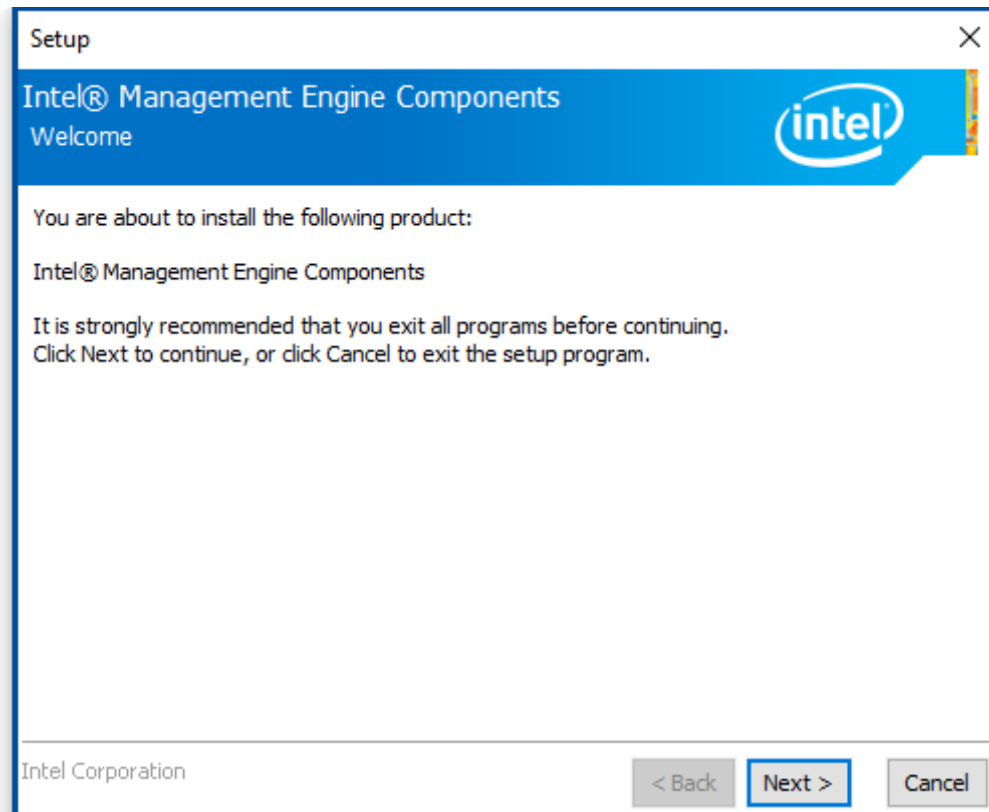

Step3. Choose I accept the terms in the License Agreement and click **Next** to begin

the installation.

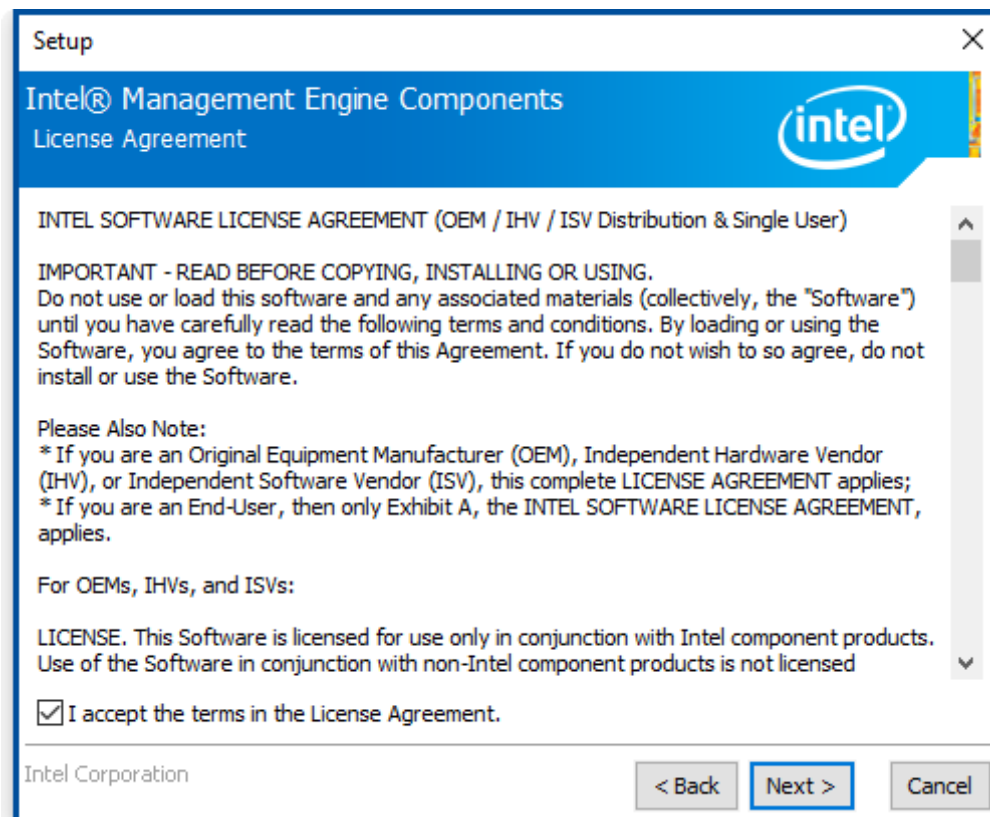

Step4. Click **Next** to continue.

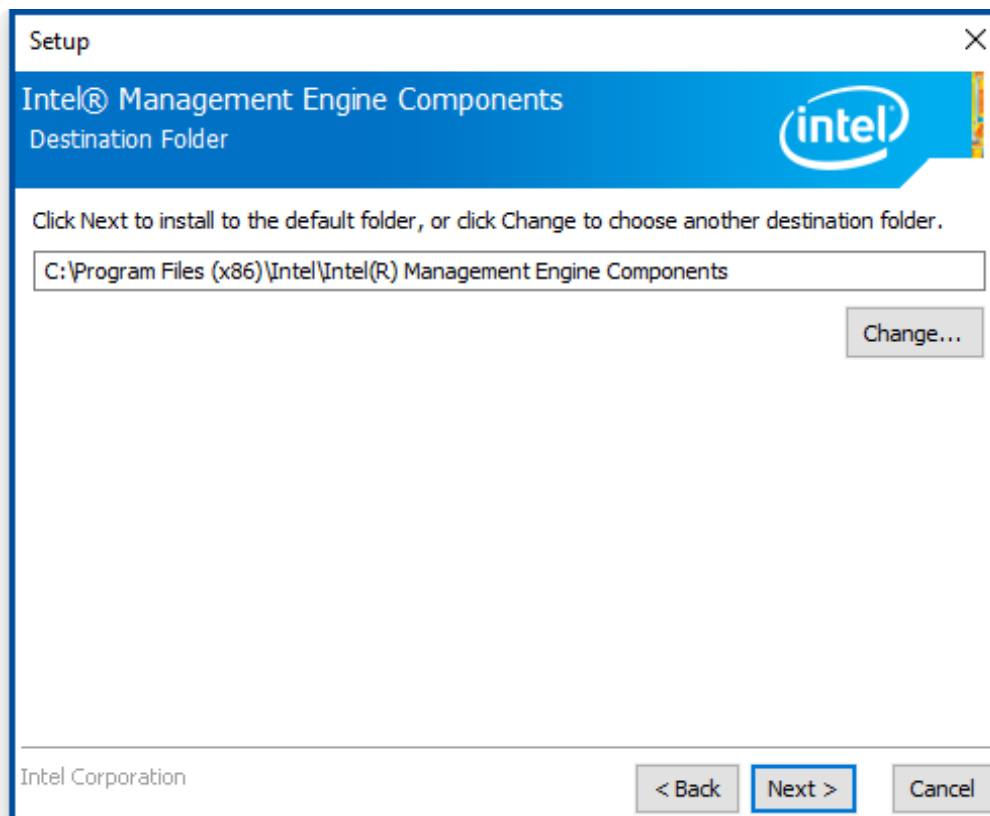

Step5. Click **Finish** to complete the installation.

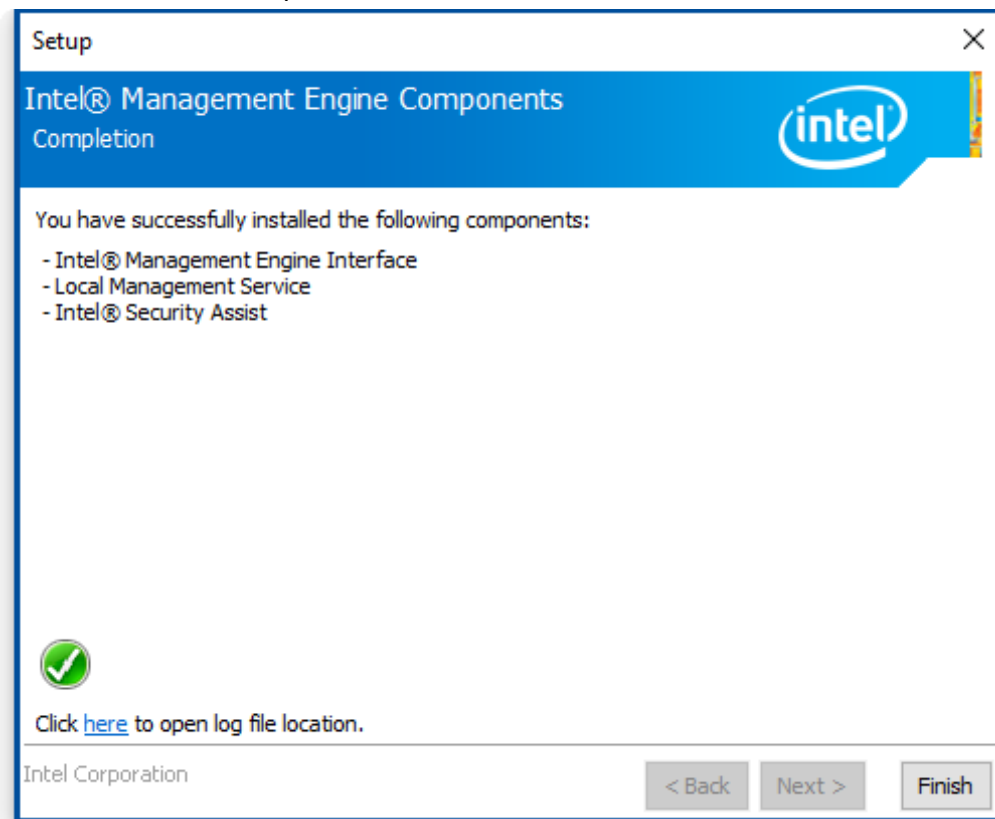

4.5 DPTF Driver

To install the DPTF Driver, please follow the steps below.

Step1. Select **DPTF Driver** from the list



Step2. Click **Next** to continue.

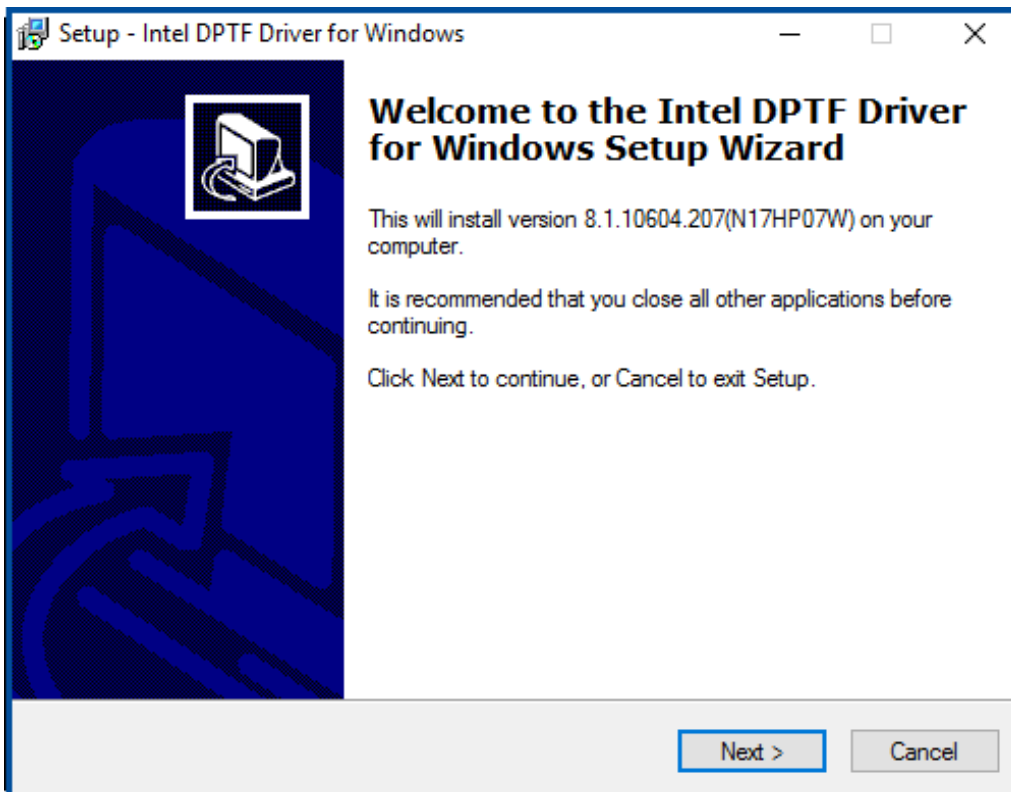

Step3. Read the license agreement. Choose **Accept** and click **Next** to accept all of the terms of the license agreement.

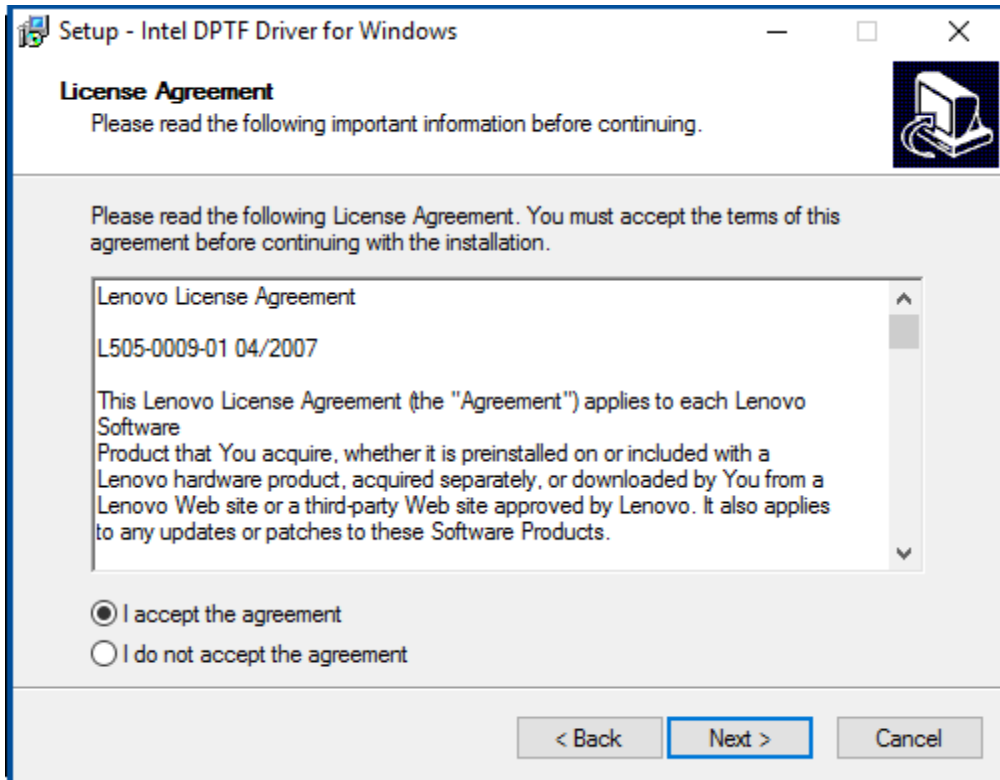

Step4. Select destination location by your option and click **Next** to continue.

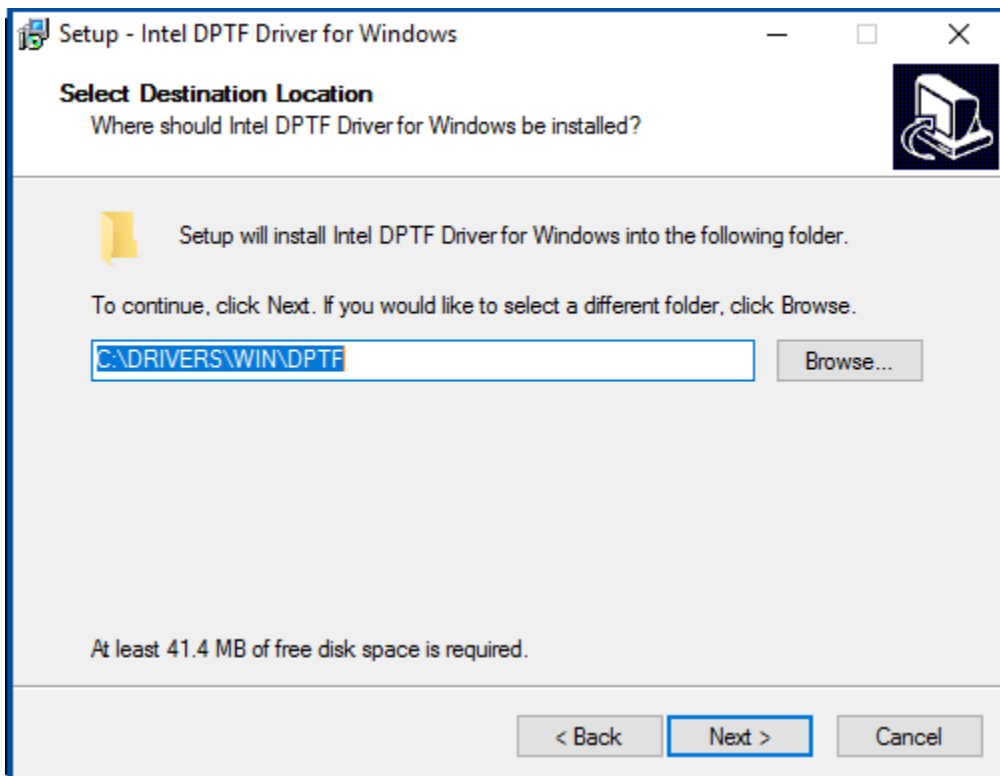

Step5. Click **Install** to continue the installing.

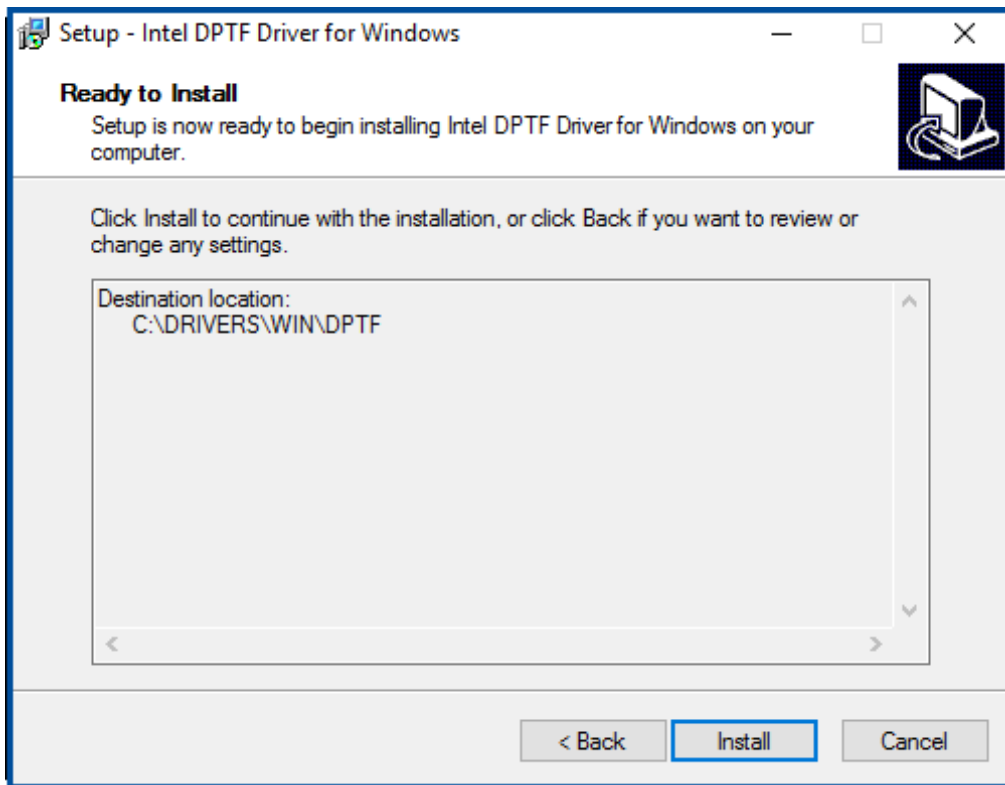

Step6. Click **Finish** to complete the installation and start install Intel DPTF driver for Windows.

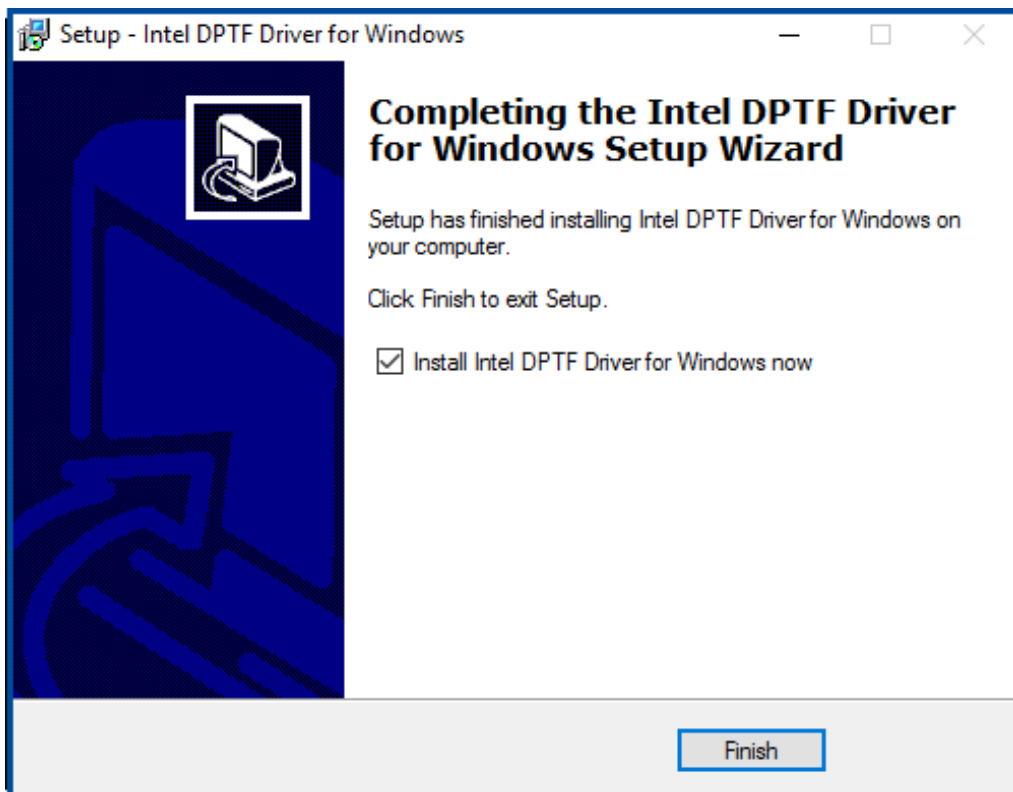

Step7. Click **Next** to start the installation.

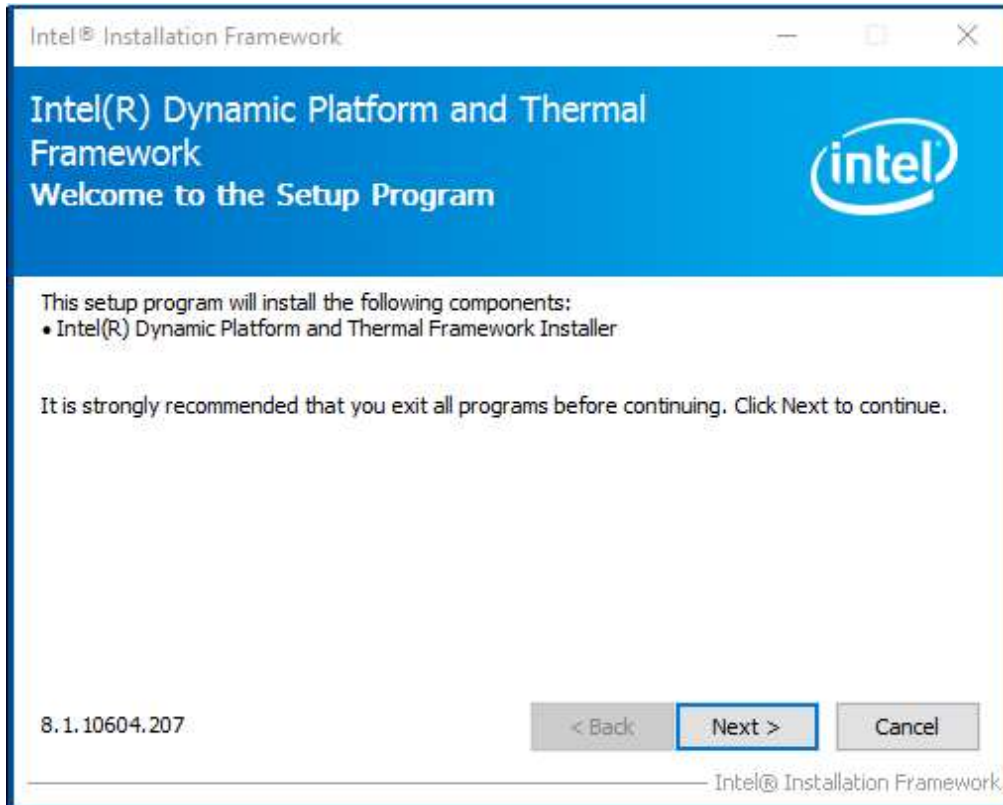

Step8. Read the license agreement. Click **Yes** to accept all of the terms of the license agreement.

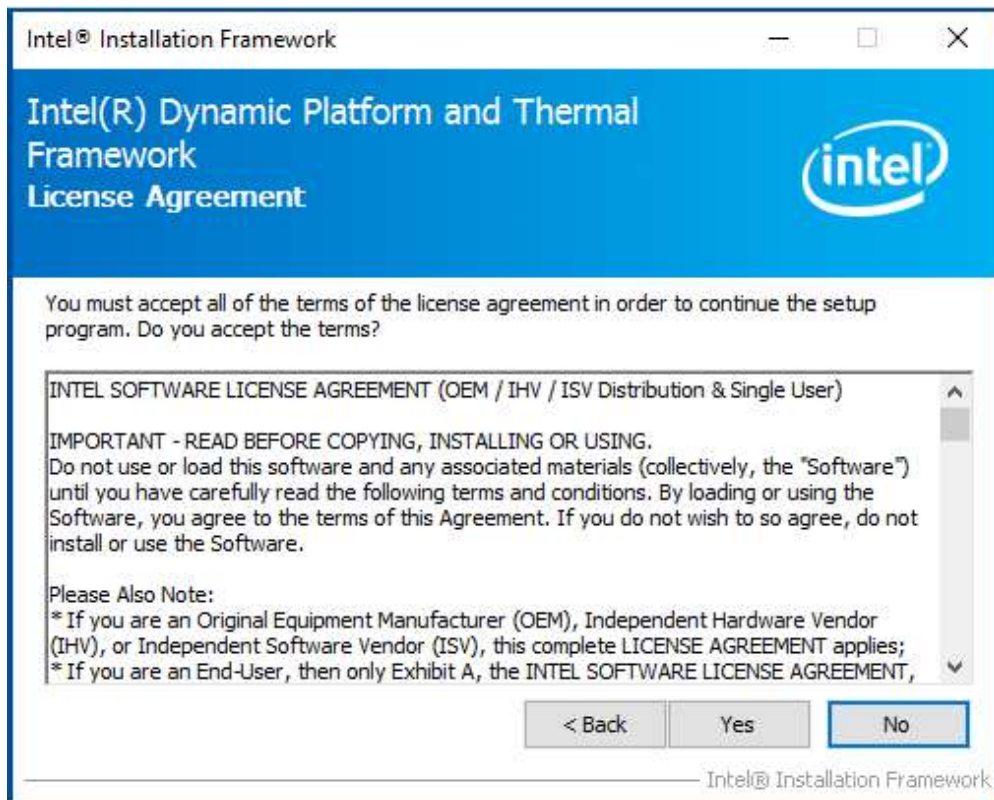

Step9. Click **Next** to continue.

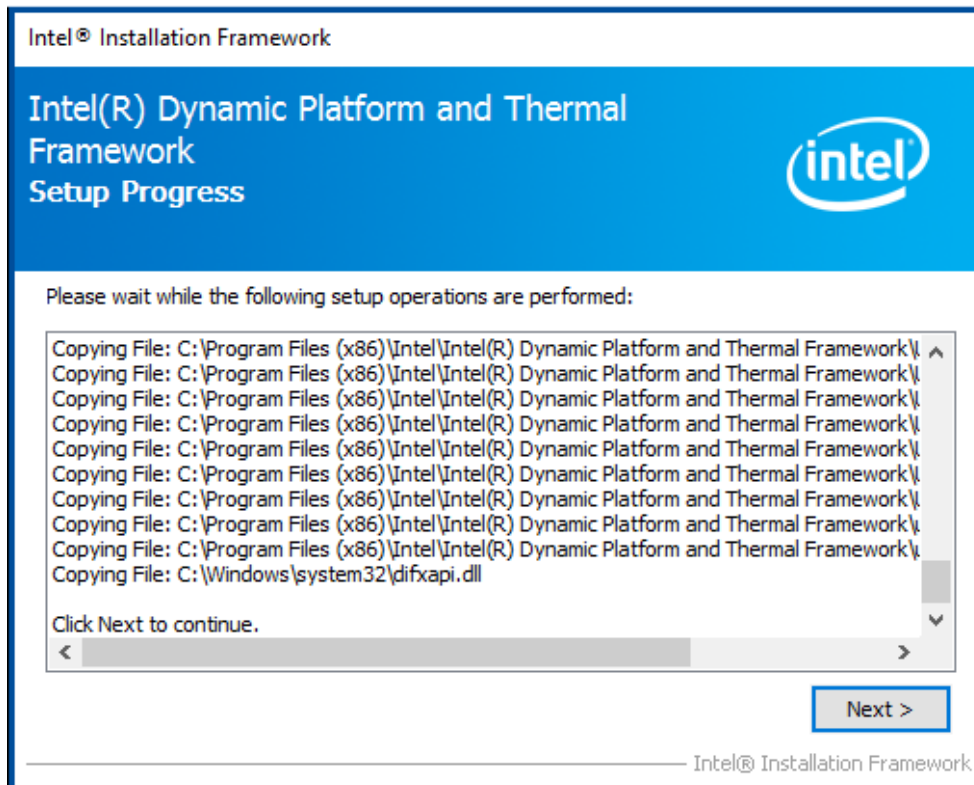

Step10. Click **Finish** to complete the installation.

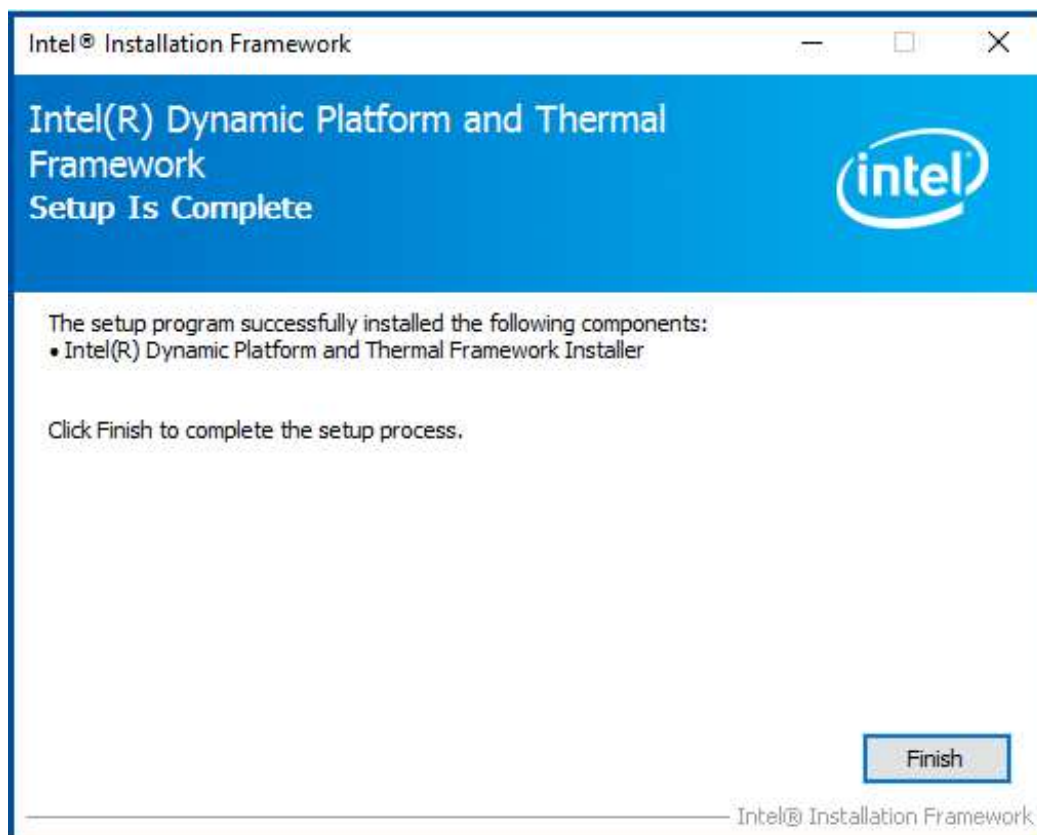

Chapter 5 Touch Screen Installation

This chapter describes how to install drivers and other software that will allow your touch screen work with different operating systems.

5.1 Windows 8.1/10 Universal Driver Installation for PenMount 6000 Series

Before installing the Windows 8.1/10 driver software, you must have the Windows 8.1/10 system installed and running on your computer. You must also have one of the following PenMount 6000 series controller or control boards installed: PM6500, PM6300.

Resistive Touch

If you have an older version of the PenMount Windows 7 driver installed in your system, please remove it first. Follow the steps below to install the PenMount DMC6000 Windows 7 driver.

Step1. Insert the product CD, the screen below would appear. Click **Touch Panel Driver** from the list.



Step2. Click **Next** to continue.



Step3. Read the license agreement. Click **I Agree** to agree the license agreement.

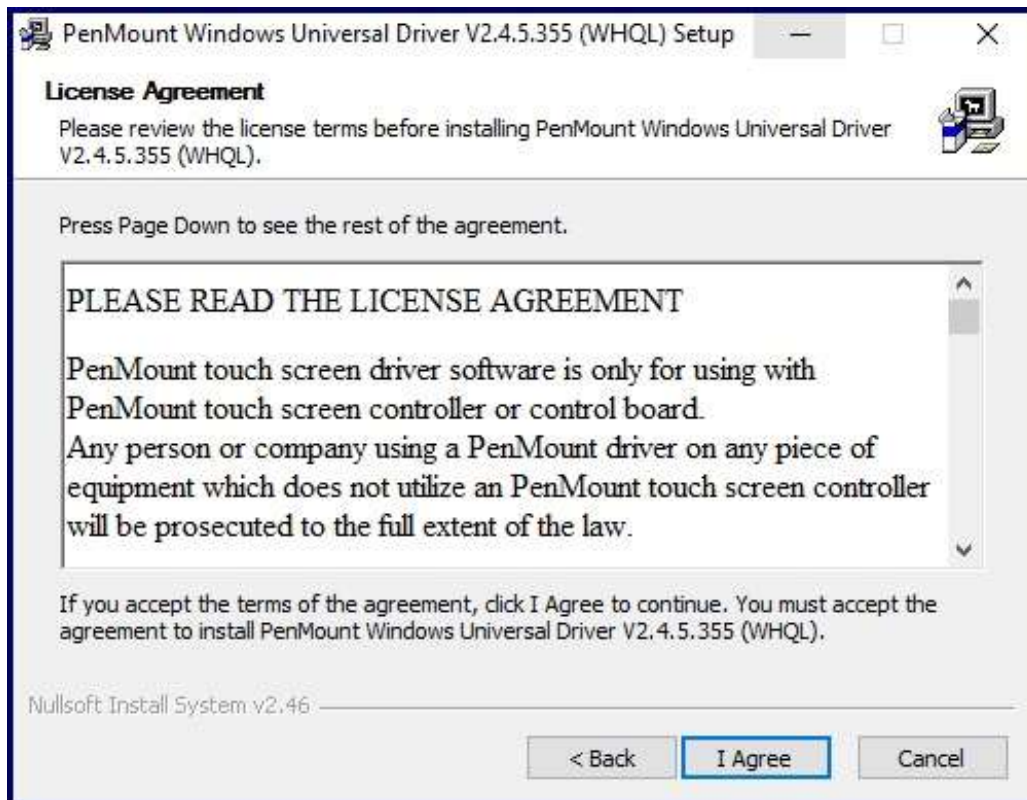

Step4. Choose the folder in which to install PenMount Windows Universal Driver. Click **Install** to start the installation.

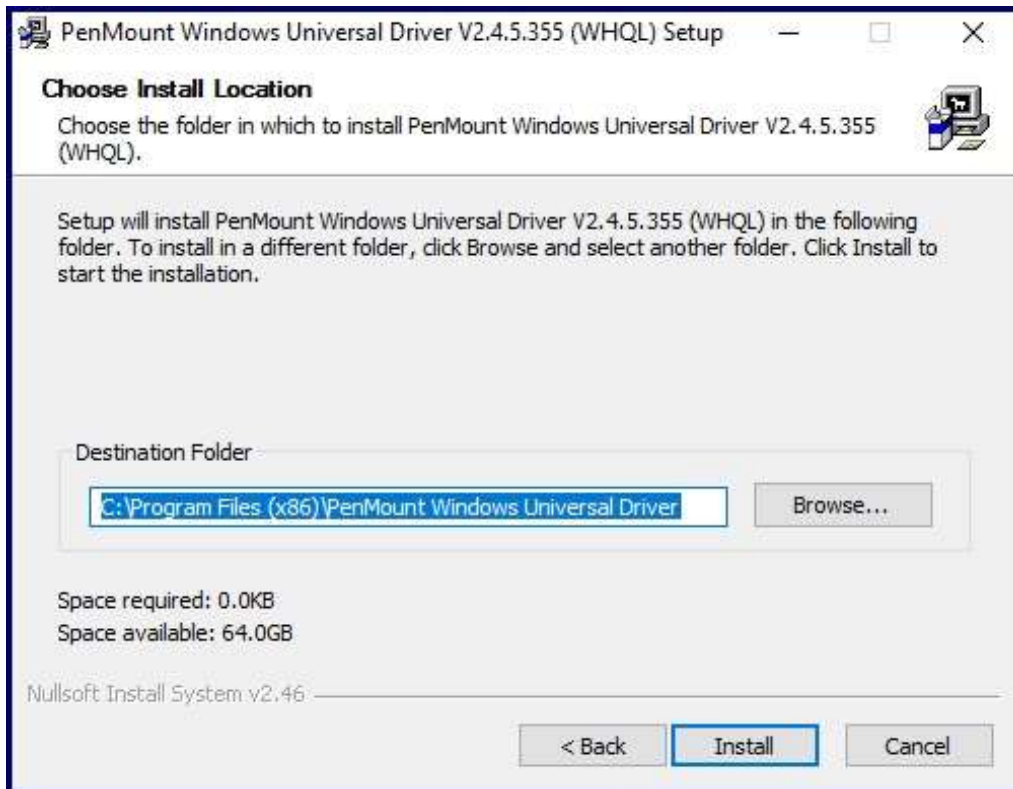

Step5. Click **Yes** to continue.

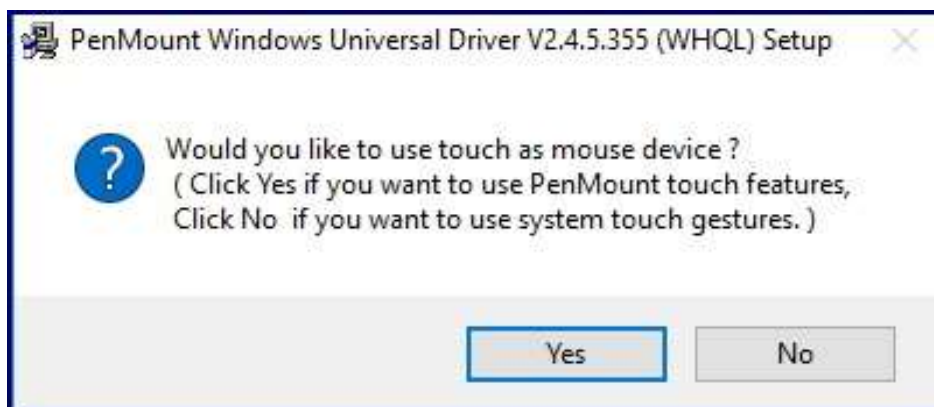

Step6. Click **Finish** to complete installation.

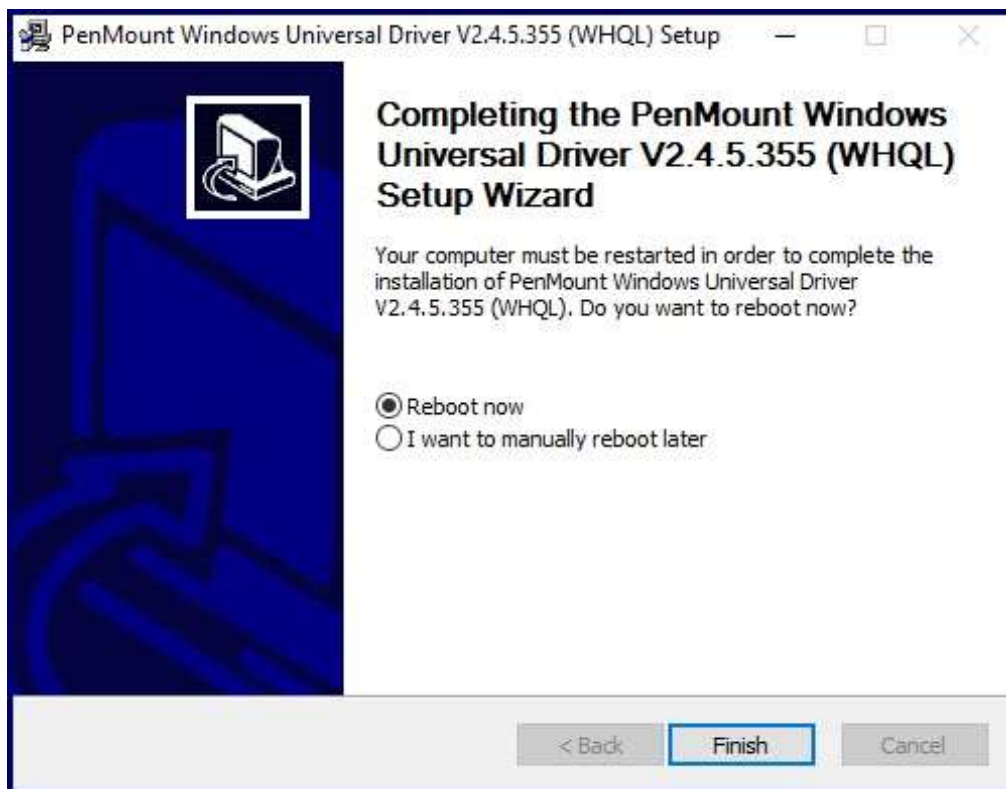

5.2 Software Functions

Resistive Touch

Upon rebooting, the computer automatically finds the new 6000 controller board. The touch screen is connected but not calibrated. Follow the procedures below to carry out calibration.

1. After installation, click the PenMount Monitor icon “PM” in the menu bar.
2. When the PenMount Control Panel appears, select a device to “Calibrate.”

PenMount Control Panel(Resistive Touch)

The functions of the PenMount Control Panel are **Device**, **Multiple Monitors**, **Tools** and **About**, which are explained in the following sections.

Device

In this window, you can find out that how many devices be detected on your system.

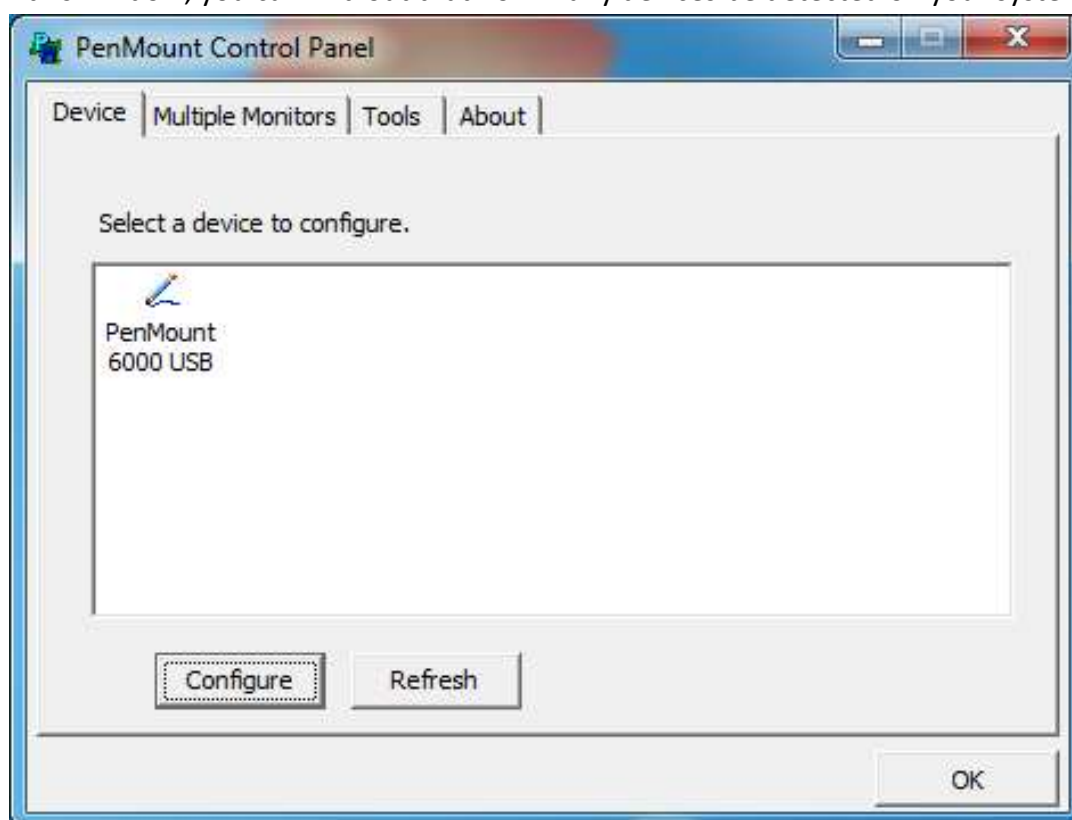

Calibrate

This function offers two ways to calibrate your touch screen. 'Standard Calibration' adjusts most touch screens. 'Advanced Calibration' adjusts aging touch screens.

Standard Calibration	Click this button and arrows appear pointing to red squares. Use your finger or stylus to touch the red squares in sequence. After the fifth red point calibration is complete. To skip, press 'ESC'.
Advanced Calibration	Advanced Calibration uses 4, 9, 16 or 25 points to effectively calibrate touch panel linearity of aged touch screens. Click this button and touch the red squares in sequence with a stylus. To skip, press ESC'.

Step1. Please select a device then click "Configure". You can also double click the device too.

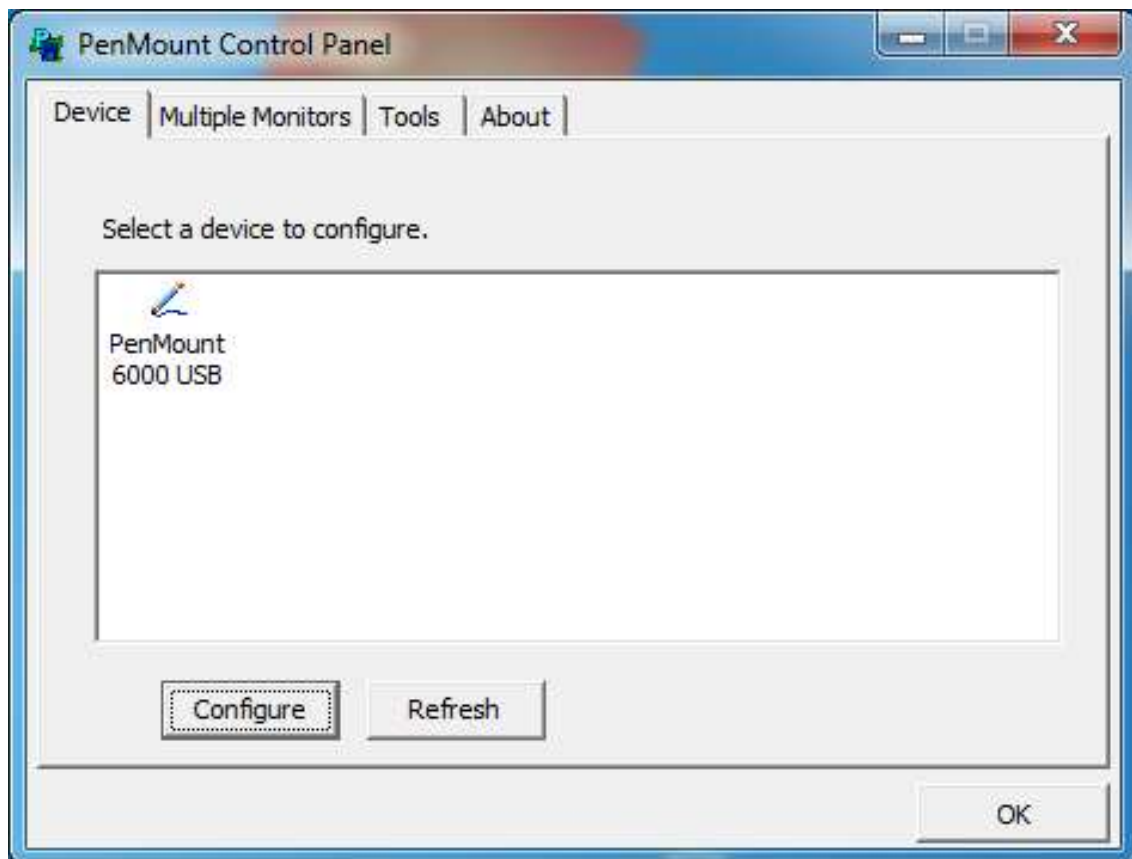

Step2.Click “**Standard Calibration**” to start calibration procedure

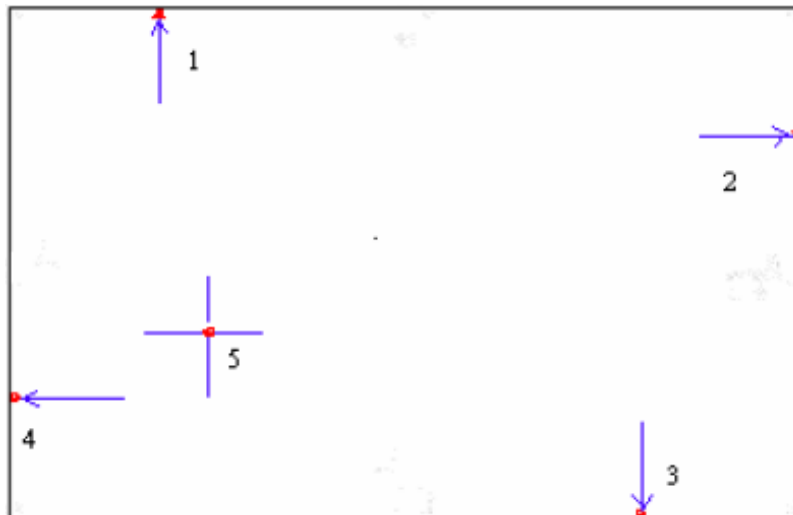
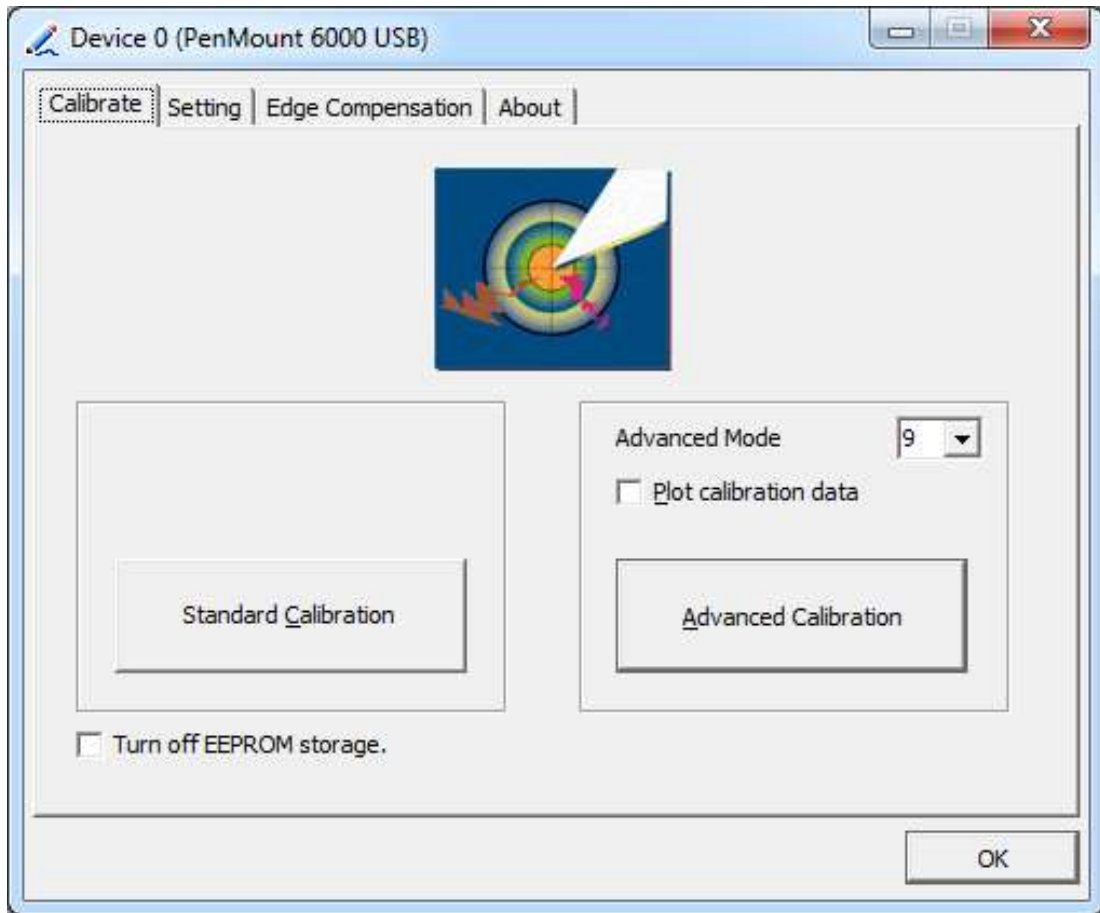

NOTE: The older the touch screen, the more Advanced Mode calibration points you need for an accurate calibration. Use a stylus during Advanced Calibration for greater accuracy. Please follow the step as below:

Step3. Select **Device** to calibrate, then you can start to do **Advanced Calibration**.

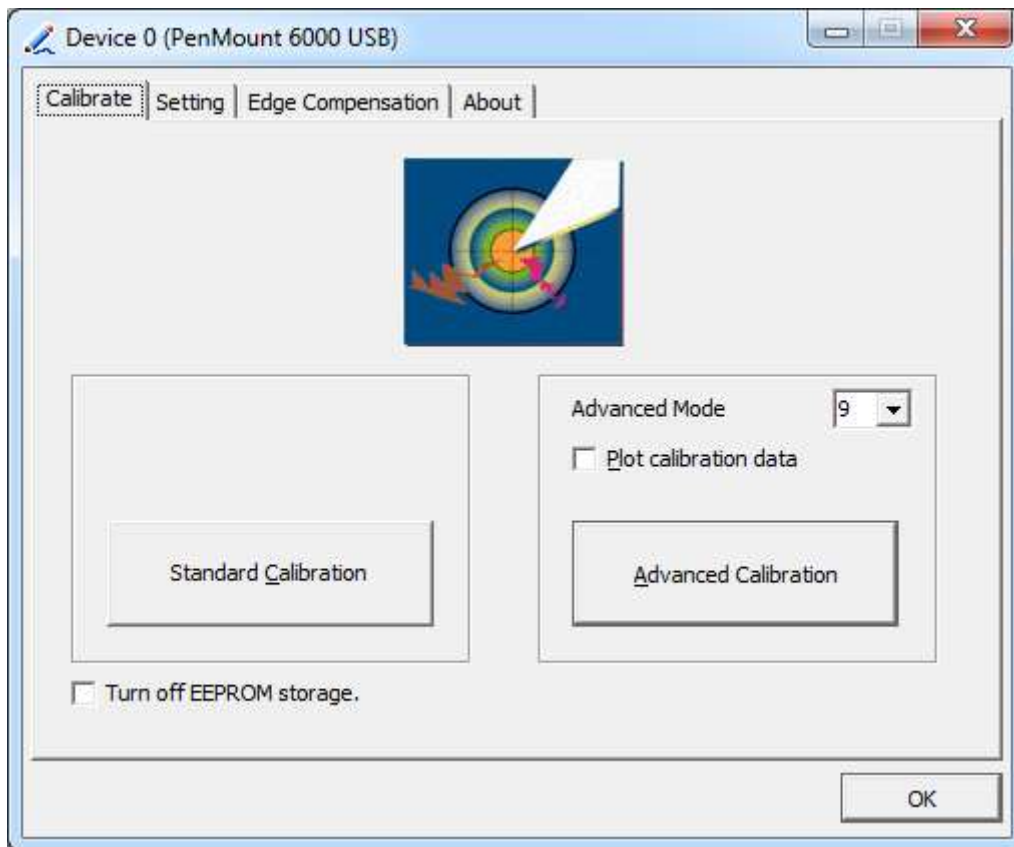

NOTE: Recommend to use a stylus during Advanced Calibration for greater accuracy.



Plot Calibration Data	Check this function and a touch panel linearity comparison graph appears when you have finished Advanced Calibration. The blue lines show linearity before calibration and black lines show linearity after calibration.
Turn off EEPROM storage	The function disable for calibration data to write in Controller. The default setting is Enable.

Setting

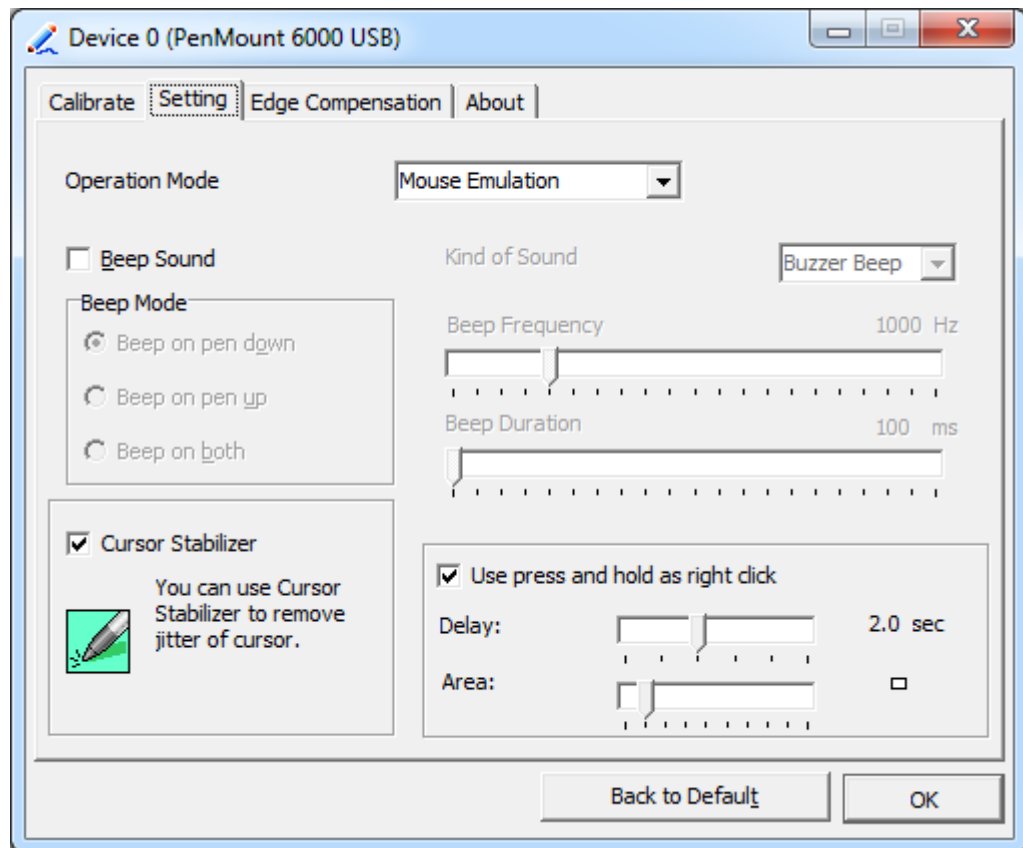

Touch Mode	<p>This mode enables and disables the mouse’s ability to drag on-screen icons – useful for configuring POS terminals.</p> <p>Mouse Emulation – Select this mode and the mouse functions as normal and allows dragging of icons.</p> <p>Click on Touch – Select this mode and mouse only provides a click function, and dragging is disables.</p>
Beep Sound	<p>Enable Beep Sound – turns beep function on and off</p> <p>Beep on Pen Down – beep occurs when pen comes down</p> <p>Beep on Pen Up – beep occurs when pen is lifted up</p> <p>Beep on both – beep occurs when comes down and lifted up</p> <p>Beep Frequency – modifies sound frequency</p> <p>Beep Duration – modifies sound duration</p>
Cursor Stabilizer	<p>Enable the function support to prevent cursor shake.</p>
Use press and hold as right click	<p>You can set the time out and area for you need.</p>

Edge Compensation

You can use Edge Compensation to calibrate more subtly.

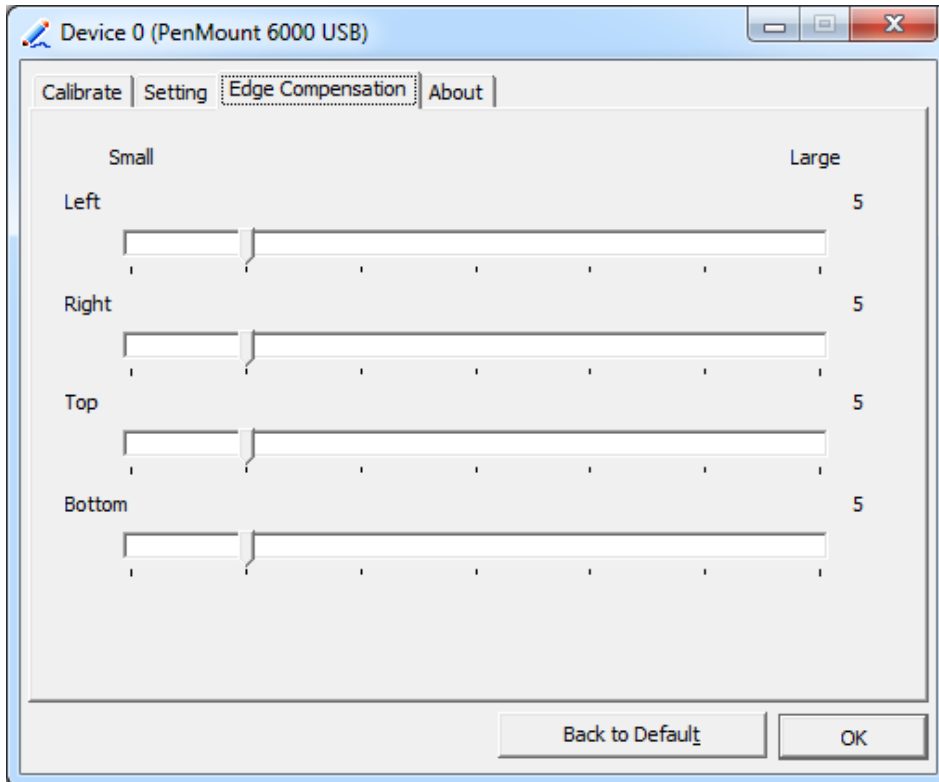

About

This panel displays information about the PenMount controller and driver version.

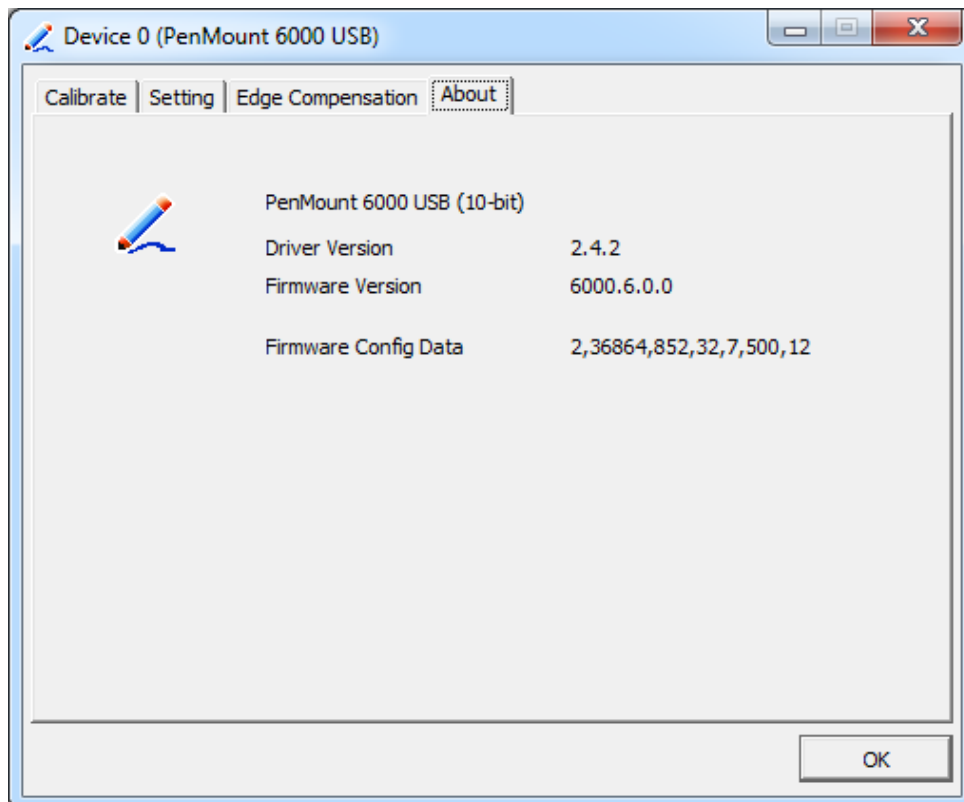

Multiple Monitors

Multiple Monitors support from two to six touch screen displays for one system. The PenMount drivers for Windows 7/8/8.1 support Multiple Monitors. This function supports from two to six touch screen displays for one system. Each monitor requires its own PenMount touch screen control board, either installed inside the display or in a central unit. The PenMount control boards must be connected to the computer COM ports via the USB interface. Driver installation procedures are the same as for a single monitor. Multiple Monitors support the following modes:

- Windows Extends Monitor Function
- Matrox DualHead Multi-Screen Function
- nVidia nView Function

NOTE: The Multiple Monitor function is for use with multiple displays only. Do not use this function if you have only one touch screen display. Please note once you turn on this function the rotating function is disabled.

Enable the multiple display function as follows:

1. Check the **Enable Multiple Monitor Support** box; then click **Map Touch Screens** to assign touch controllers to displays.

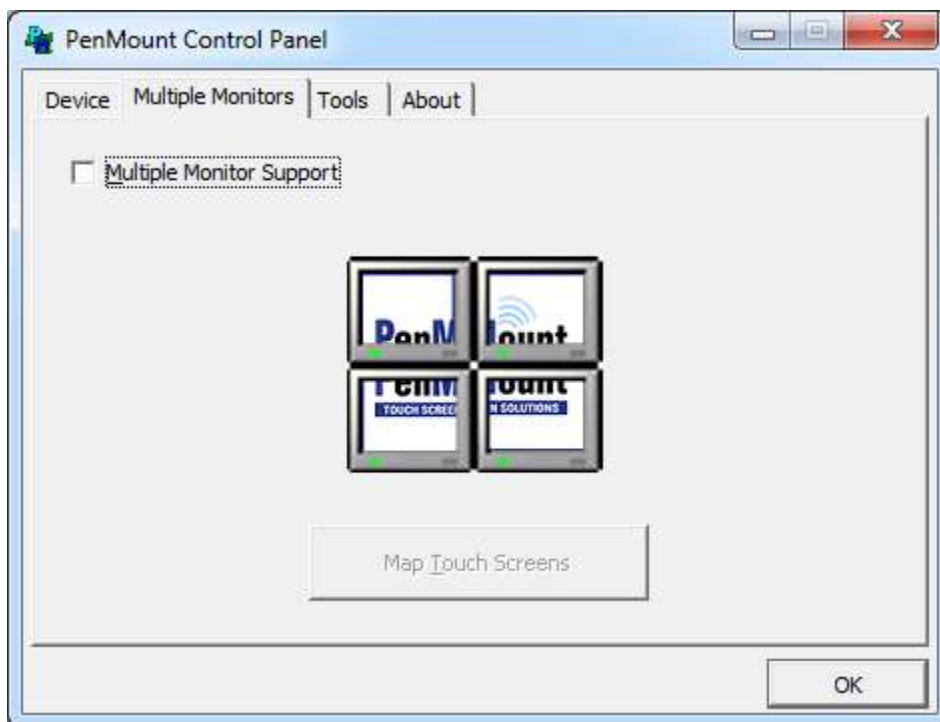

2. When the mapping screen message appears, click **OK**.
3. Touch each screen as it displays “Please touch this monitor”. Following this sequence and touching each screen is called **mapping the touch screens**.

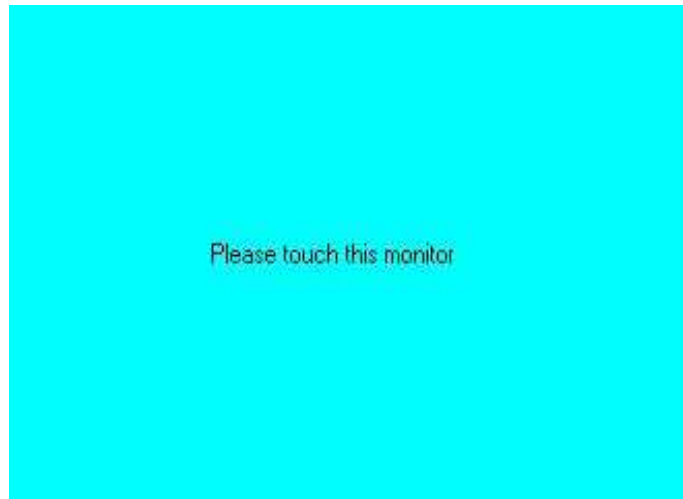

4. Touching all screens completes the mapping and the desktop reappears on the monitors.
5. Select a display and execute the "Calibration" function. A message to start calibration appears. Click **OK**.



6. "Touch this screen to start its calibration" appears on one of the screens. Touch the screen.
7. "Touch the red square" messages appear. Touch the red squares in sequence.
8. Continue calibration for each monitor by clicking **Standard Calibration** and touching the red squares.

NOTES:

1. If you use a single VGA output for multiple monitors, please do not use the **Multiple Monitor** function. Just follow the regular procedure for calibration on each of your desktop monitors.
2. The Rotating function is disabled if you use the Multiple Monitor function.
3. If you change the resolution of display or screen address, you have to redo **Map Touch Screens**, so the system understands where the displays are.

About

This panel displays information about the PenMount controller and this driver version.

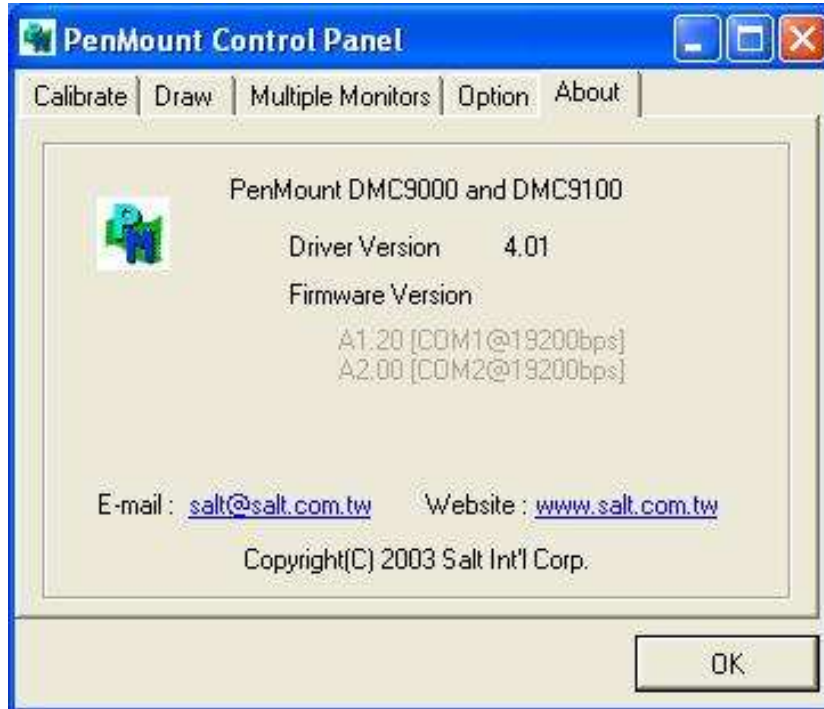

PenMount Monitor Menu Icon

The PenMount monitor icon (PM) appears in the menu bar of Windows 7/8/8.1 system when you turn on PenMount Monitor in PenMount Utilities.



PenMount Monitor has the following function



Control Panel	Open Control Panel Windows
Beep	Setting Beep function for each device
Right Button	When you select this function, a mouse icon appears in the right-bottom of the screen. Click this icon to switch between Right and Left Button functions.
Exit	Exits the PenMount Monitor function.



Configuring the Rotate Function

1. Install the rotation software package.
2. Choose the rotate function (0°, 90°, 180°, 270°) in the 3rd party software. The calibration screen appears automatically. Touch this point and rotation is mapped.

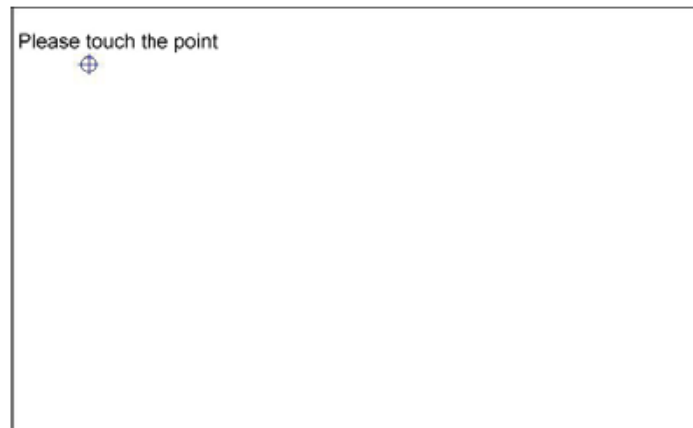

NOTE: The Rotate function is disabled if you use Monitor Mapping